

# 新北市教網中心

無線網路設定實作

無線行動箱設計

支援教師

李 煒

[alfred@ntpc.edu.tw](mailto:alfred@ntpc.edu.tw)

80723456#517

新北市教網



# 課程時間分配

時間	課程內容
13:00-14:00	無線網路設定 網路架構說明、Radius Server、NTPC、 NTPCRoaming
14:10-15:00	NTPC-Mobile 802.1X NTPC-WPA2 L3無線路由
15:10-16:00	FAT AP認證 THIN AP設定(CAWAP vs 固定AC ip) DWC2000 WPA2認證Web Portal認證 L3 MAC認證 Tunnel Mode、Bridge Mode、Router Mode Firewall Mobile 認證 VS SNGN架構 AutoProvision Profile

# 新北市高國中小學校園網路架構

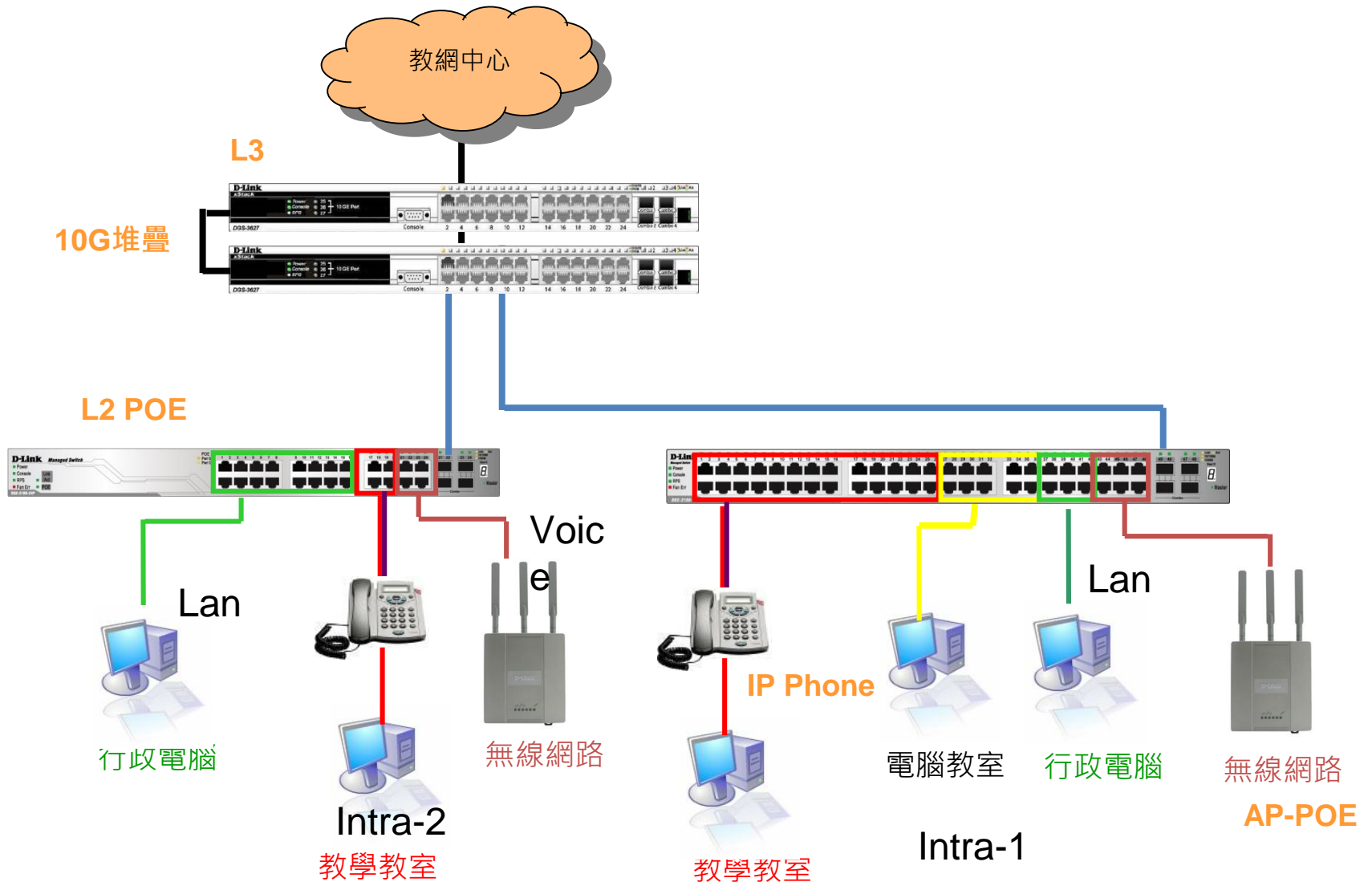

# 學校IP網段說明

Vlan	VID	網段	IPv6	用途
Mgt	1	10.226.76.254	2001:288:22xx:1::/64	網管用
Wan	2	163.20.203.89/29	2001:288:2201::/124	對外連結網段
Lan	5	163.20.172.254/24	2001:288:22xx:5::/64	行政用
dsa_wan	8	10.253.76.254/24	2001:288:22xx:8::/64	DSA-WAN IP (10.253.76.1)
Intra-1	10	10.231.76.254/24	2001:288:22xx:10::/64	電腦教室
Intra-2	20	10.241.76.254/24	2001:288:22xx:20::/64	教學教室
Voice	25	10.243.76.0/24	2001:288:22xx:25::/64	VoIP
Wlan	30	10.251.76.254/24	2001:288:22xx:30::/64	無線網路 (IP移至 DSA-3600使用)
WPA2	35	10.245.76.0/24	2001:288:22xx:35::/64	無線WAP2用
MAC	36	10.247.76.0/24	2001:288:22xx:36::/64	無線Mobile用

# Radius Server

- Authenticator(Dlink 3620 )帶的HOST IP
- Radius Server(Winoc )是否已經加入 Authenticator ip
- Key 「共享密碼」 (Shared secret)
- Firewall udp port 1812-1813

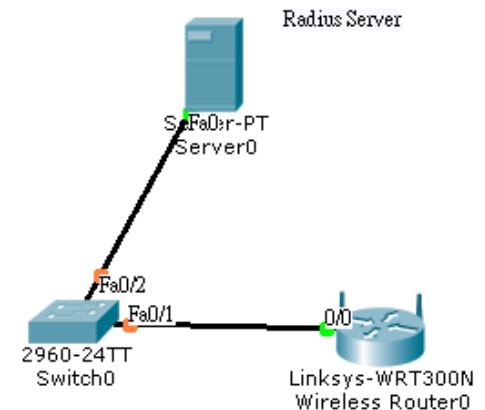
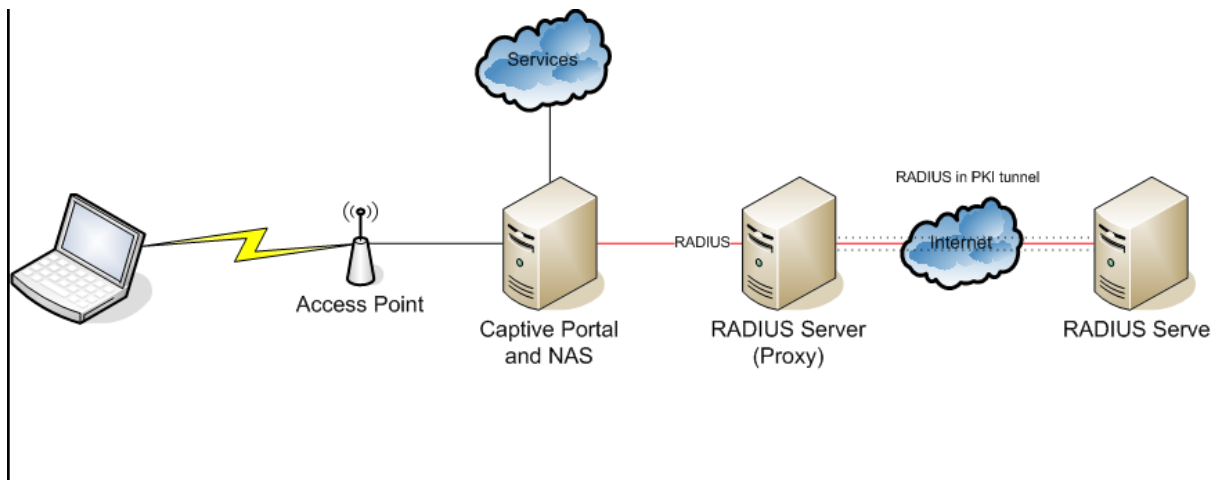

# Radius Server

- Authenticator(Dlink 3620 )帶的HOST IP
- Radius Server(Winoc )是否已經加入 Authenticator ip
- Key 「共享密碼」 (Shared secret)
- Firewall udp port 1812-1813

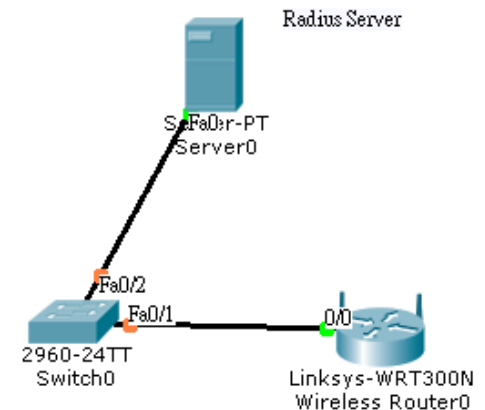
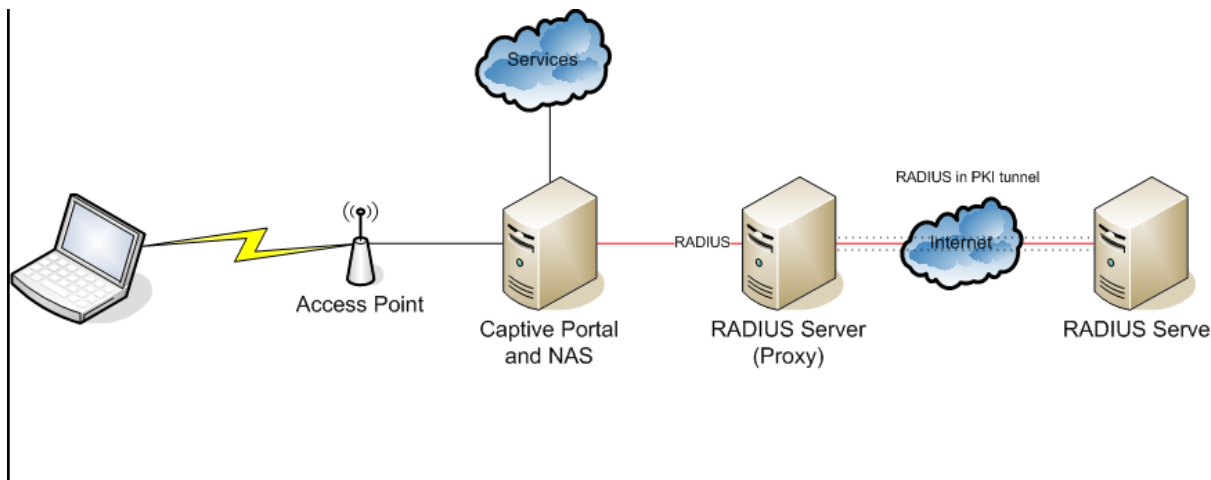

# Radius Server

- Authenticator(Dlink 3620 )帶的HOST IP
- Radius Server(Winoc )是否已經加入 Authenticator ip
- Key 「共享密碼」 (Shared secret)
- Firewall udp port 1812-1813

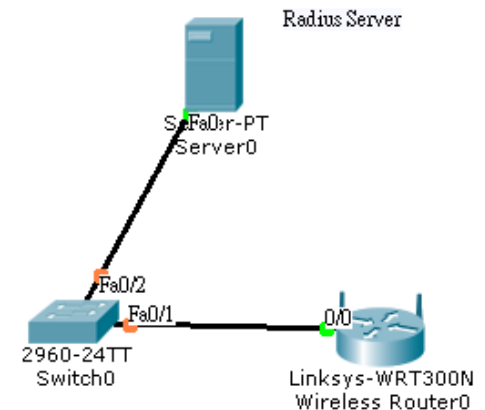
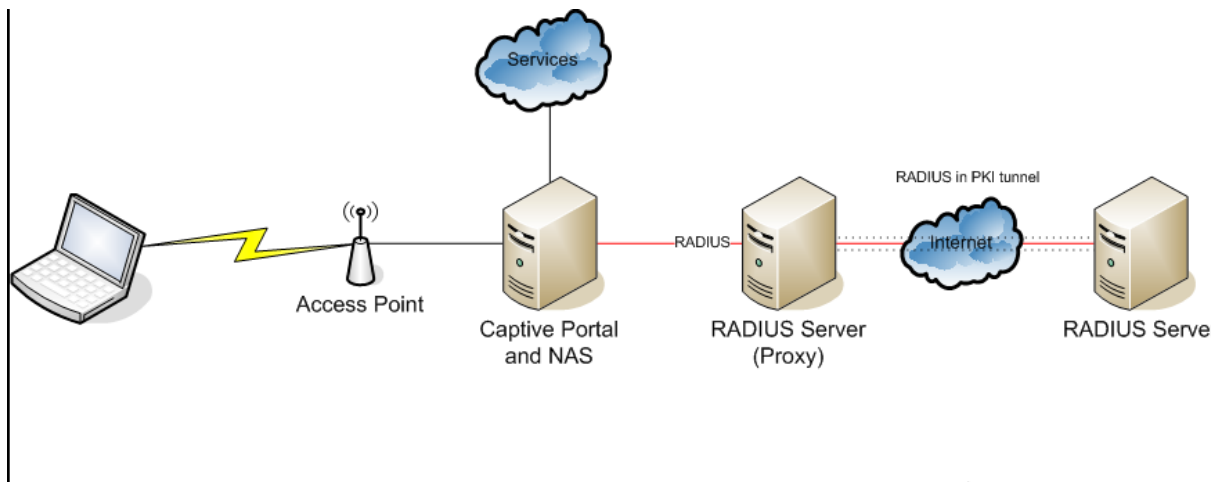

# 無線網路環境類型

- 家庭小型無線網路環境
  - Cisco Linksys 、 Dlink...
  - 隱藏SSID + Password
- 中型校園網路
  - 學校SNGN架構，路由設定
  - Local User認證
- 大型區域網路
  - Radius認證
  - Thin AP





# 家庭式網路

- Cisco PT6.0
- 模擬AP設定
  - WAN(PPPoE,Static ip)
  - WLAN
  - LAN
  - DHCP
  - NAT

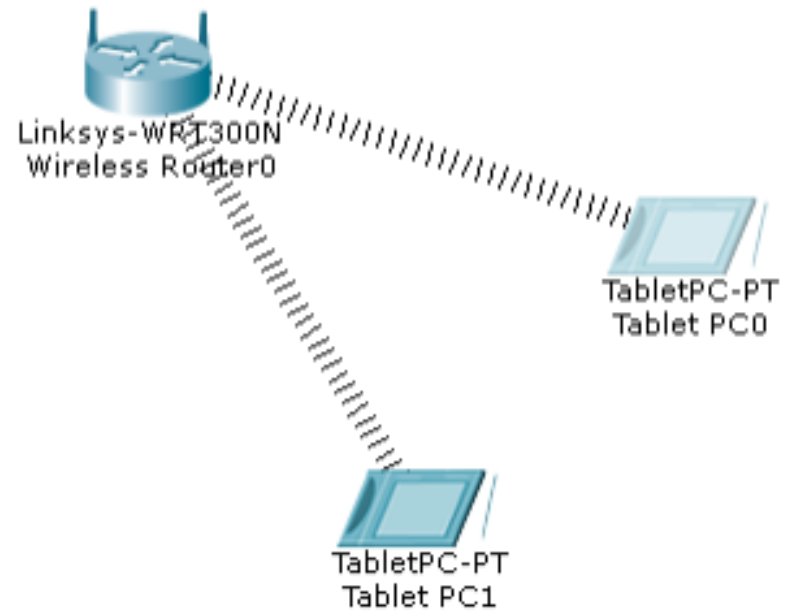

# 無線AP設定

設定分為三部分

WAN IP (internet)  
對外連線

LAN IP  
內部有線

Wireless  
內部無線

SSID

WPA2

Preshare key

Radius server

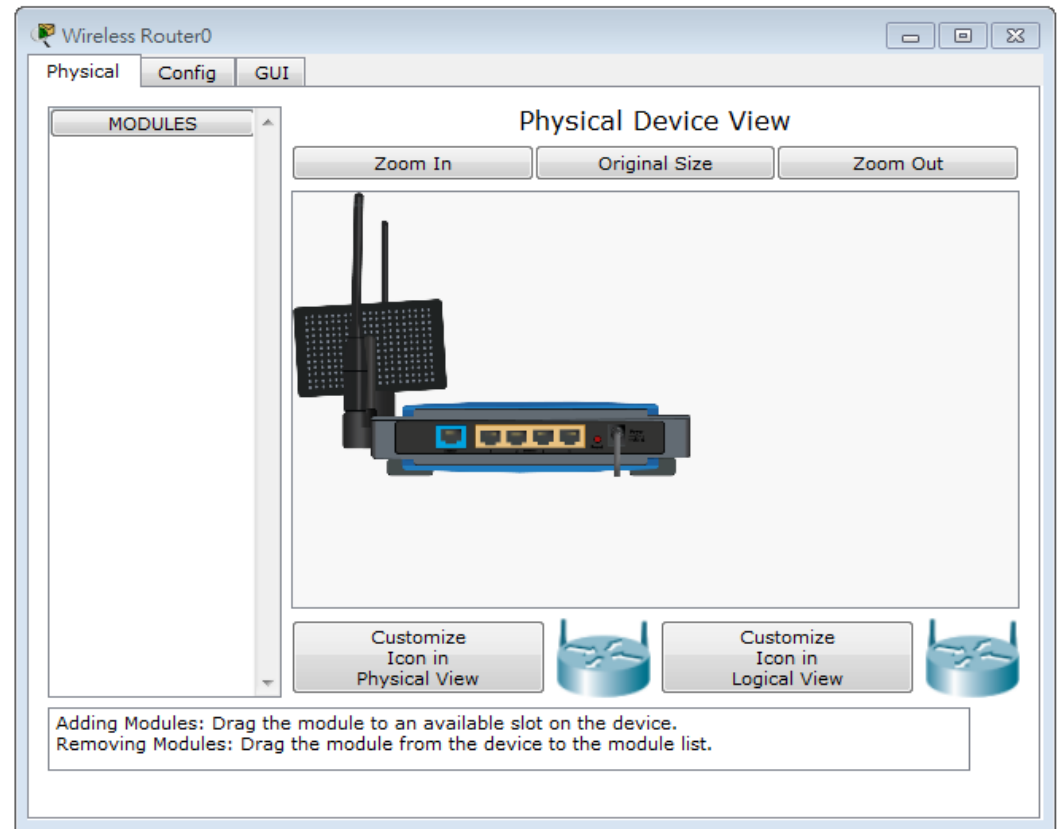

Setup

Setup

Wireless

Security

Access Restrictions

Applications & Gaming

Administration

Status

Basic Setup

DDNS

MAC Address Clone

Advanced Routing

Internet Setup

Internet Connection type

Automatic Configuration - DHCP

Optional Settings (required by some internet service providers)

Host Name:

Domain Name:

MTU:  Size:

Network Setup

Router IP

IP Address:  .  .  .

Subnet Mask:

DHCP Server Settings

DHCP Server:  Enabled  Disabled

Start IP Address:

Maximum number of Users:

IP Address Range:  -

Client Lease Time:  minutes (0 means one day)

Static DNS 1:  .  .  .

Help...

- GLOBAL**
- Settings
- Algorithm Settings
- INTERFACE**
- ✓ Internet
- ✓ LAN
- ✓ Wireless

Connection Type:

- DHCP
- Static
- PPPoE

- Default Gateway
- IP Address
- Subnet Mask
- DNS Server
- UserName
- Password

**Internet Settings**

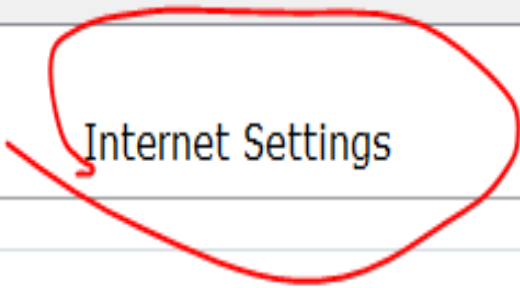

# Lab1 基本網路設定

功能要求

- 1.用一台L2 switch
- 2.接一台無線AP
- 3.讓PC可以取得ip
- 4.讓無線載具可以取得ip
- 5.無線載具與PC互ping會通

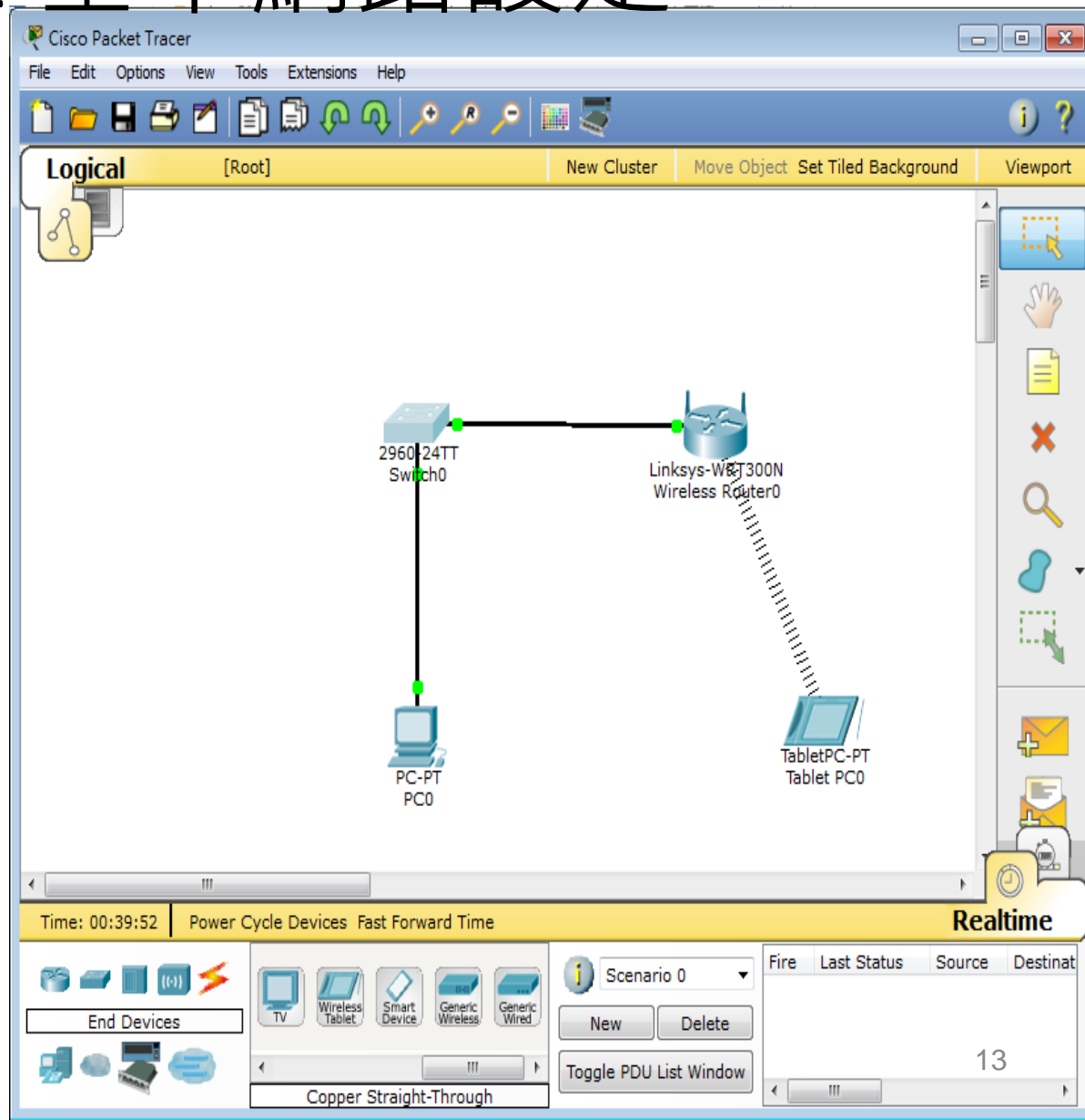



Logical

[Root]

New Cluster

Move Object Set Tiled Background

Viewport

Lab1 功能要求：

- 1.無線AP
- 2.Lan 10.247.56.0/24 DHCP指派
- 3.分別接一個無線設備及有線設備
- 4.無線載具及有線均自動取得ip

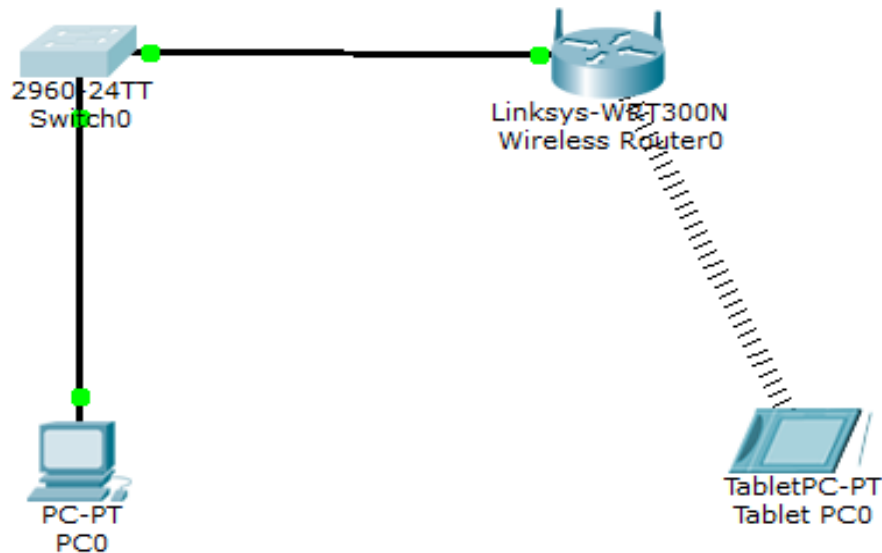

Time: 00:39:52

Power Cycle Devices Fast Forward Time

Realtime



End Devices



Copper Straight-Through

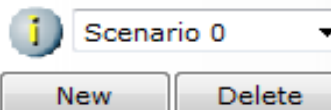

Toggle PDU List Window

Fire Last Status Source Destinat

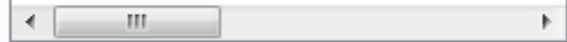

# DHCP問題發生原因LAB及排除

- Linksys LAB
- 內網DHCP取得192.168.X.X問題
- 判斷方式及故障排除  
是否取得正確的vlan ip上enctc.ntpc.edu.tw確認
- 若有錯誤ip,請工程師查出發dhcp的port , shutdown port
- 校內若是沒有私設DHCP請工程師上DHCP snooping設定。
  - [DHCP snooping防堵私自架設DHCP伺服器](#)

# 各校分配網段查詢

<https://enctc.ntpc.edu.tw>

[首頁](#) > [網路服務](#) > [網路設定](#) > [連線單位IPv4分配](#)

## 連線單位IPv4分配

連線單位	行政用LAN網段	電腦教室 (intra-1)	教學用 (intra-2)	網路電話VoIP	無線網路NTPC	無線網路WPA2	無線網路Mobile	NAT IP Range
欽賢 國中- 鼻頭 分校	163.20.182.64/27	10.231.0.0/24	10.241.0.0/24	10.243.0.0/24	10.251.0.0/24	10.245.0.0/24	10.247.0.0/24	163.20.242.252
福和 國中	163.20.173.0/24	10.231.67.0/24	10.241.67.0/24	10.243.67.0/24	10.251.67.0/24	10.245.67.0/24	10.247.67.0/24	163.20.242.1
中和 國中	163.20.120.0/24	10.231.2.0/24	10.241.2.0/24	10.243.2.0/24	10.251.2.0/24	10.245.2.0/24	10.247.2.0/24	163.20.242.2
三峽 國中	163.20.129.0/24	10.231.3.0/24	10.241.3.0/24	10.243.3.0/24	10.251.3.0/24	10.245.3.0/24	10.247.3.0/24	163.20.242.3
中國 國小	163.20.62.0/25	10.231.4.0/24	10.241.4.0/24	10.243.4.0/24	10.251.4.0/24	10.245.4.0/24	10.247.4.0/24	163.20.242.4
安溪 國小	163.20.95.128/25	10.231.5.0/24	10.241.5.0/24	10.243.5.0/24	10.251.5.0/24	10.245.5.0/24	10.247.5.0/24	163.20.242.5
昌福 國小	163.20.239.128/25	10.231.6.0/24	10.241.6.0/24	10.243.6.0/24	10.251.6.0/24	10.245.6.0/24	10.247.6.0/24	163.20.242.6



# Vlan 2 Default Route

路由器位址：學校Dlink L3 vlan2 interface ip

預設閘道：中心端Fortigate 3950 firewall Vdom interface ip

[首頁](#) > [網路服務](#) > [網路設定](#) > [光纖連線單位](#)

## 光纖連線單位

單位名稱	分區別	區	專線號碼	路由器位址	子網路遮罩	預設閘道
青山國中小	七星分區	汐止區	264YD000013	163.20.202.57	255.255.255.248	163.20.202.62
樟樹國中	七星分區	汐止區	264YD000014	163.20.202.65	255.255.255.248	163.20.202.70
長安國小	七星分區	汐止區	264YD000020	163.20.202.169	255.255.255.248	163.20.202.174
北峰國小	七星分區	汐止區	264YD000002	163.20.208.193	255.255.255.248	163.20.208.198
北港國小	七星分區	汐止區	264YD000003	163.20.208.201	255.255.255.248	163.20.208.206
汐止國中	七星分區	汐止區	264YD000004	163.20.208.209	255.255.255.248	163.20.208.214
市立秀峰高中	七星分區	汐止區	264YD000005	163.20.209.1	255.255.255.248	163.20.209.6
秀峰國小	七星分區	汐止區	264YD000006	163.20.209.9	255.255.255.248	163.20.209.14
金龍國小	七星分區	汐止區	264YD000007	163.20.209.17	255.255.255.248	163.20.209.22
東山國小	七星分區	汐止區	264YD000010	163.20.209.25	255.255.255.248	163.20.209.30
崇德國小	七星分區	汐止區	264YD000008	163.20.209.97	255.255.255.248	163.20.209.102
樟樹國小	七星分區	汐止區	264YD000009	163.20.209.169	255.255.255.248	163.20.209.174
白雲國小	七星分區	汐止區	227YD000208	163.20.209.193	255.255.255.248	163.20.209.198
汐止國小	七星分區	汐止區	264YD000011	163.20.209.233	255.255.255.248	163.20.209.238
保長國小	七星分區	汐止區	264YD000012	163.20.209.241	255.255.255.248	163.20.209.246

# 校園網路Lab拓譜圖

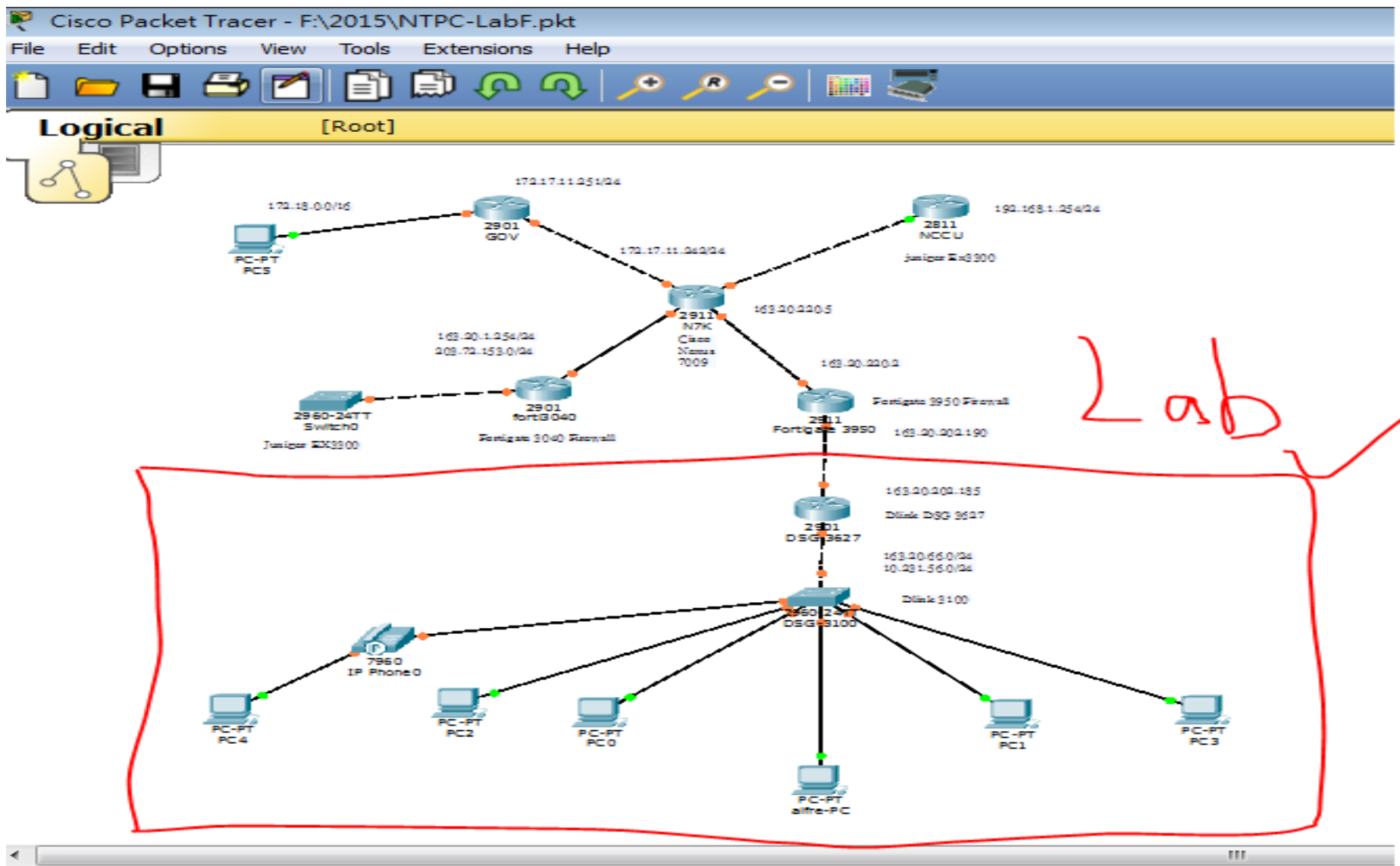

# 看懂SNGN管理網站及用途

- Sngn.enctc.ntpc.edu.tw
- 網路拓譜圖
- 無線網路拓譜圖
- L3 ip
- L2 ip
- AP Controller ip
- TroubleShoot



# 編碼說明

- S site survey 場勘時的設備
- N 新設備
- O 舊設備
- Sn 堆疊n台
- 已使用port
- 預估使用port
- 學校目前線上待換L2 switch數
- 使用總port數=已使用port+ol2 port數
- 冗餘port 尚未使用port

# SNGN 設備監控

今日數據

即時數據

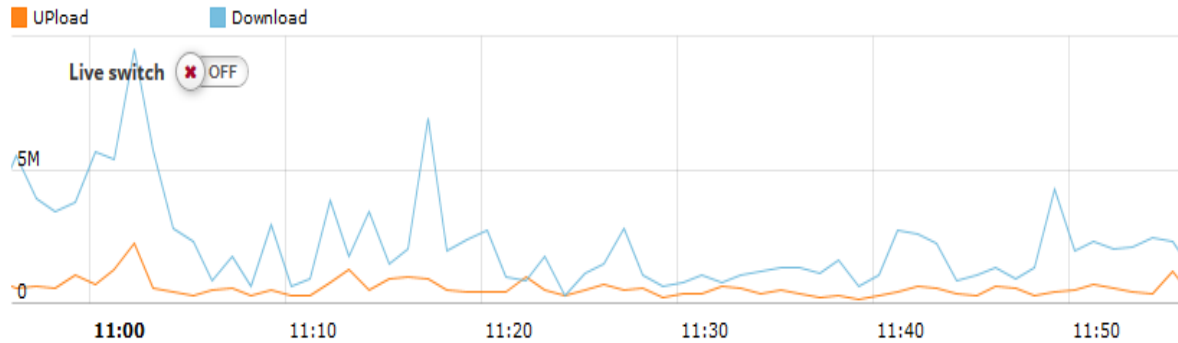

Download 2.624 Mb/ 100Mb

Upload 0.791 Mb/ 100Mb

Session 5240/ 20000

Hosts 3647/ 10000

上線設備 237/ 200

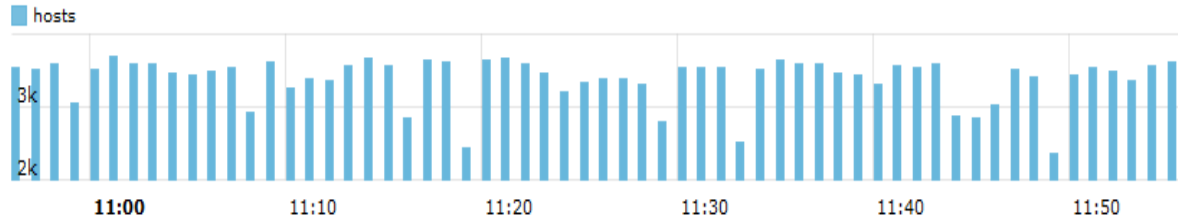

Zoom: 5分鐘 1小時 MAX

VOIP設備

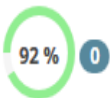

73 台  
▼ 0%

SWITCH設備



7 台  
▼ 100%

行動包設備

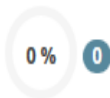

1 套  
▲ 80%

PACKET LOST

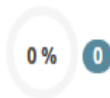

100 %  
▲ 5%

VOIP MOS



5  
▼ 3.5%

PING L3



1000 ms  
▲ 40%

# 校園無線網路介紹

# WiFi Analyzer

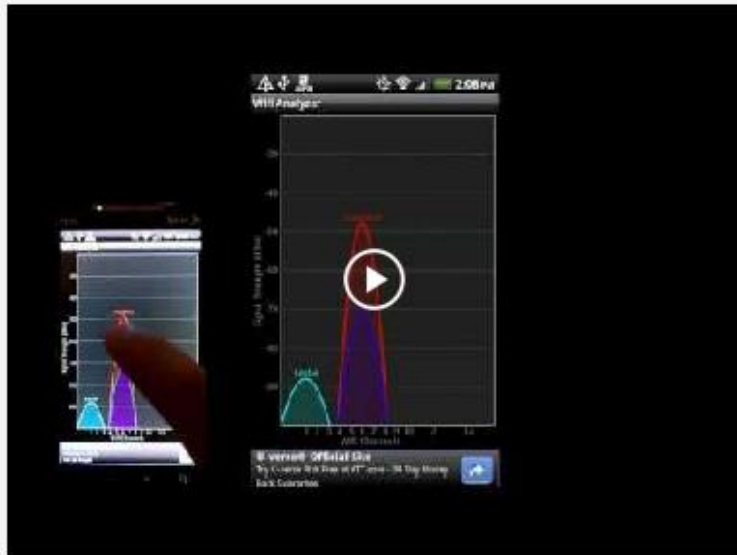

- 在2.4GHz頻段下它的理論速度能達到450Mbps
  - 在5GHz頻段下它的理論速度更能達到1300Mbps，比目前的802.11n路由器快三倍

# 802.1x

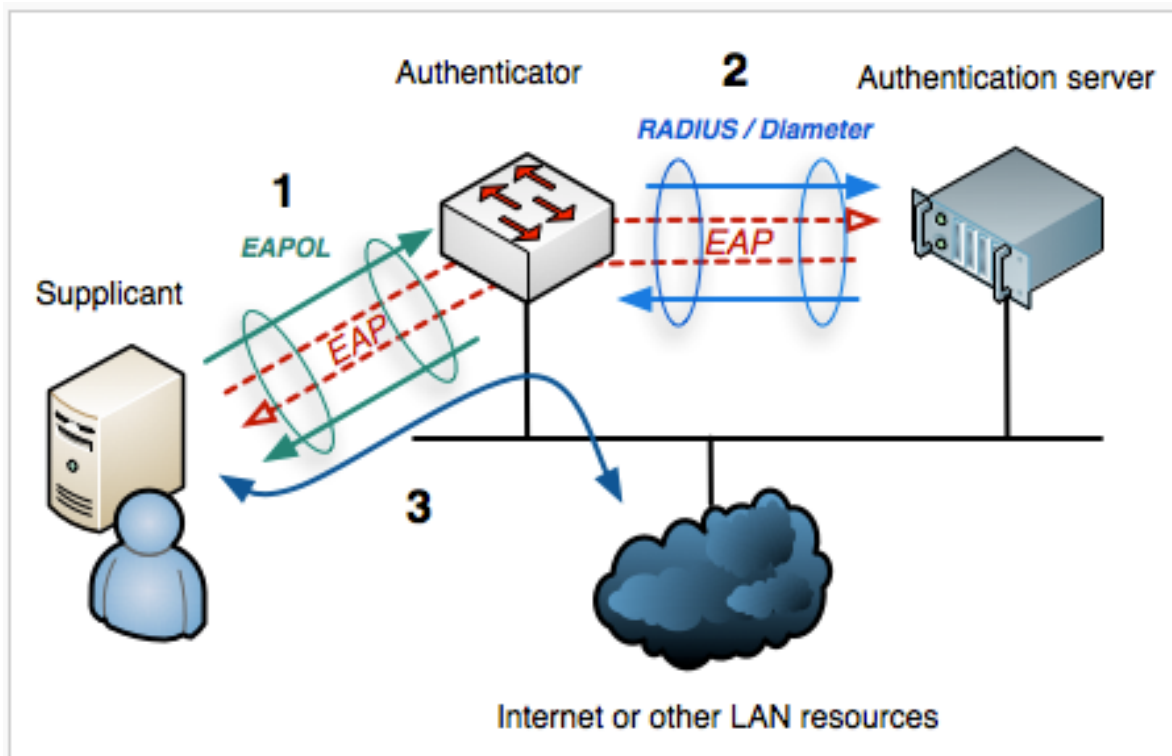

EAP數據首先被封裝在EAPOL幀中，傳輸於申請者 (Supplicant) 和驗證者 (Authenticator) 之間。隨後又封裝在RADIUS或Diameter，傳輸於驗證者和驗證伺服器 (Authentication server) 之間。

• 取自wiki



# SNGN 無線AP架構應用說明

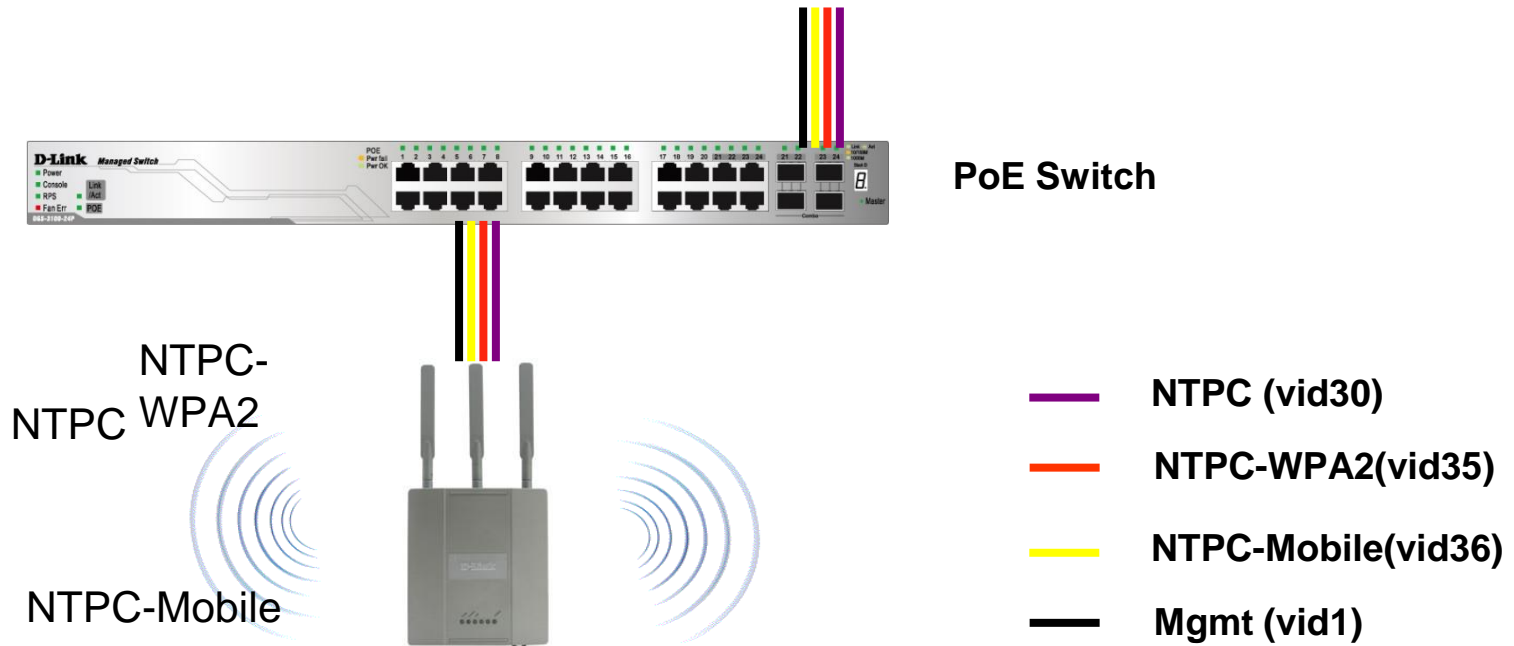

每台無線AP提供四組SSID,  
NTPC、NTPC-Roaming提供web認證功能  
NTPC-WPA2、EduRoam提供WPA2認證功能  
NTPC-Mobile提供行動裝置MAC認證功能

# 無線AP認證機制說明

DGS-3627

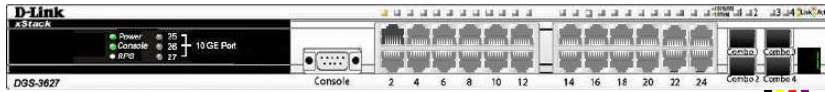

PoE Switch



WINOC

NTPC-  
NTPC WPA2

NTPC-Mobile



SSID NTPC 、NTPC-Roaming認證

透過Web-Portal與DWC-2000或Fortigate 3950B系統進行驗證

SSID NTPC-WAP2 、EduRoam則透過AP與後端認證系統進行

SSID NTPC-Mobile則透過L3 Switch與後端系統進行驗證

# SNGN 無線AP架構應用說明

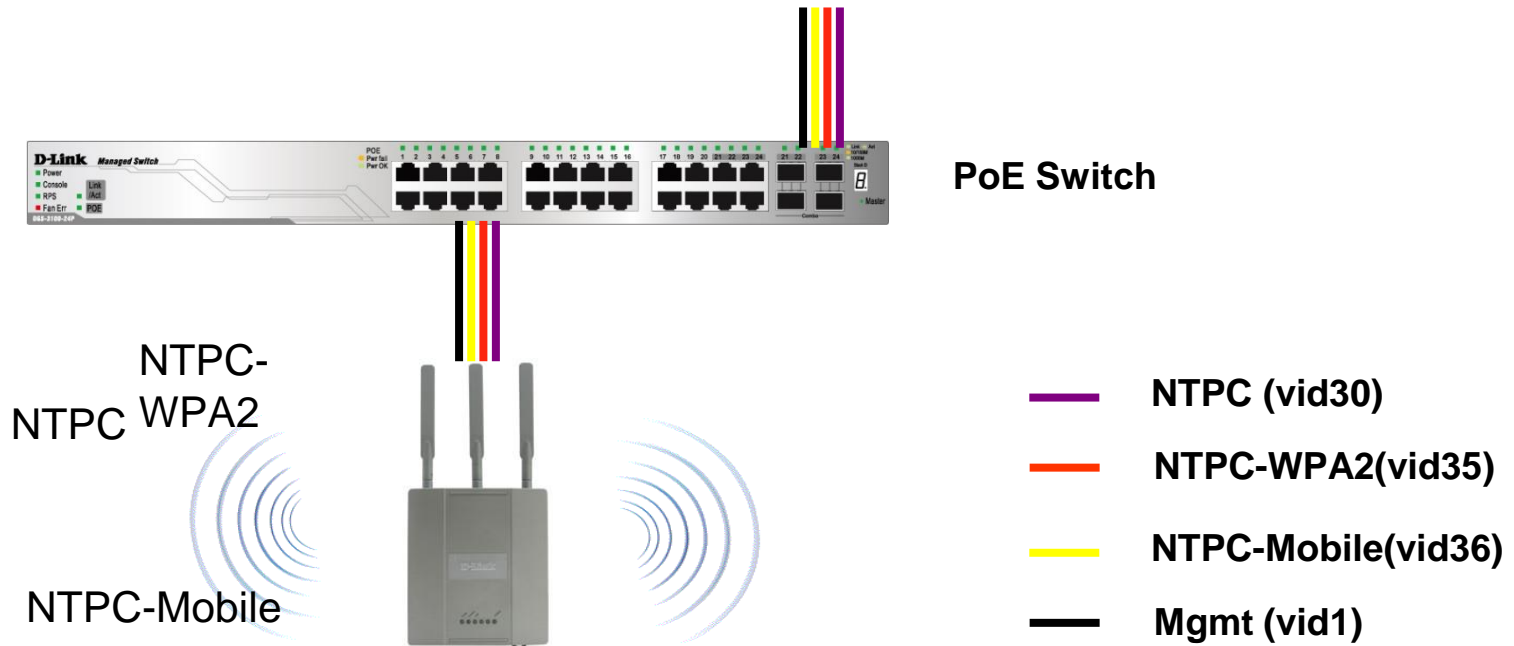

每台無線AP提供四組SSID,  
NTPC、NTPC-Roaming提供web認證功能  
NTPC-WPA2、EduRoam提供WPA2認證功能  
NTPC-Mobile提供行動裝置MAC認證功能

# Portal認證行為模式

- 1.Client連上SSID NTPC
- 2. DWC-2000無線網路控制器 or firewall認證
  - Radius Server 203.72.153.61—62 port UDP 1812 -1813
- 3.帶DWC-2000 ip (Vlan 8)送radius認證
- 4.認證通過放行
- 5.認證沒過不能用，也不會清ip
- 6.Gateway在DWC-2000 WLan
- 認證流程圖說明

# Winoc設定設備radius key

- 中芳國小
- 厚德國小
- 建安國小
- 建國國小
- 後埔國小
- 思賢國小
- 恆毅中學
- 柑林國小
- 柑園國小
- 柑園國中
- 重陽國小
- 重慶國小
- 重慶國中
- 修德國小
- 埔墘國小
- 崁腳國小
- 時雨國中
- 桃子腳國中
- 泰山高中
- 泰山國小
- 泰山國中
- 海山高中
- 海山國小
- 烏來國中小
- 貢寮國小
- 貢寮國中
- 乾華國小
- 國立三重高中
- 國光國小
- 國泰國小
- 崇林國中
- 崇德國小
- 康橋國中小
- 教研中心
- 淡水商工
- 淡水國小
- 淡水國中
- 淡江高中
- 清水高中

設備設定 設備關聯性

### 修改單一設備設定

廠牌：	Fortinet
型號：	General Controller
類型：	AG
名稱：	FG-300C
設備編號：	100
設定成RADIUS客戶端？	<input checked="" type="radio"/> 是 <input type="radio"/> 否
RADIUS共用密碼：	[REDACTED]
DNS網域：	
IP位址：	163.20.202.186
HTTP埠號：	443
SNMP埠號：	0
TCP埠號：	23
UDP埠號：	0
MAC位址：	0
SNMP唯讀密碼：	[REDACTED]
SNMP讀寫密碼：	[REDACTED]
告警啟用狀態：	<input type="radio"/> 啟用 <input checked="" type="radio"/> 停用 <input type="radio"/> 略過健康檢查
描述：	
啟始網頁：	
地點座標：	X: 0 Y: 0 <span>圖形化選取座標</span>

以下設定如有變更，會寫入到設備中

修改設備：	<input checked="" type="radio"/> 管理網頁帳號密碼 <input type="radio"/> SSID <input type="radio"/> DNS <input type="radio"/> RADIUS
管理網頁帳號：	[REDACTED] <input checked="" type="checkbox"/> 不寫入到設備
管理網頁密碼：	[REDACTED]

確定 取消

來問的設備帶的source ip

# WLAN認證架構圖

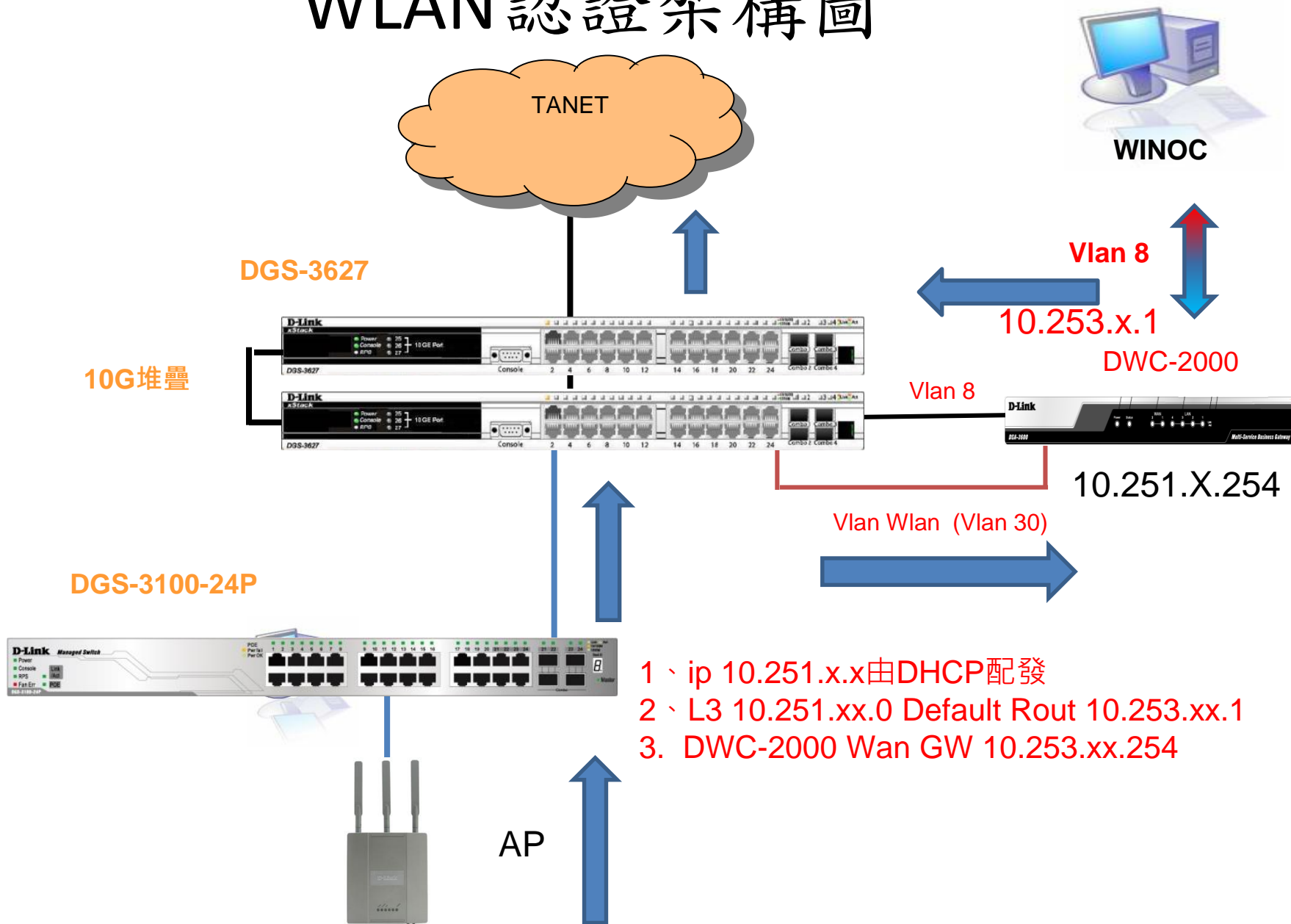

- 1、ip 10.251.x.x由DHCP配發
- 2、L3 10.251.xx.0 Default Rout 10.253.xx.1
3. DWC-2000 Wan GW 10.253.xx.254

# 新北市無線網路NTPC架構圖

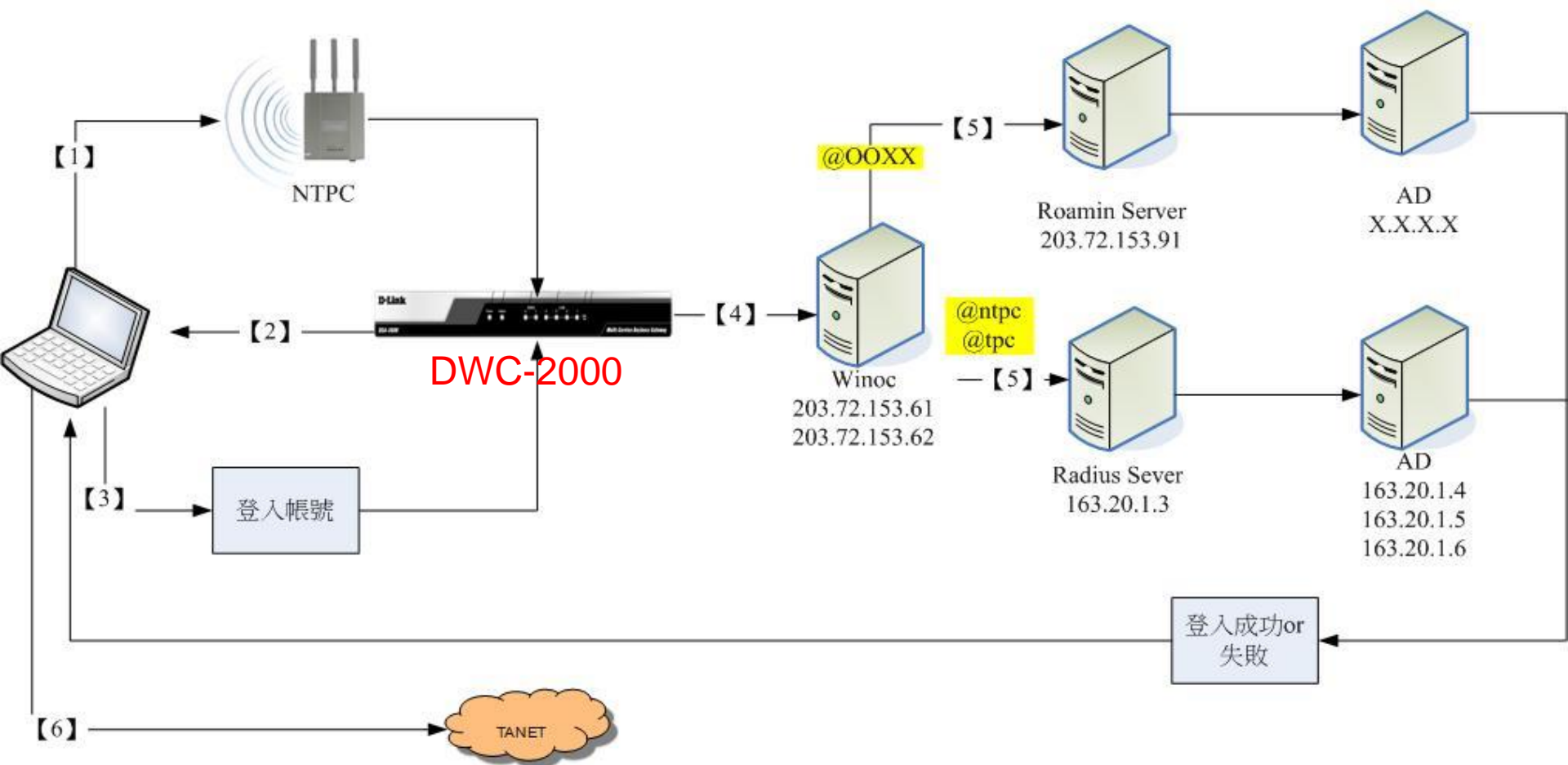

- 【1】 電腦連線NTPC
- 【2】 電腦取得10.251 or 10.252網段
- 【3】 使用者key入帳號密碼
- 【4】 如使用者只輸入帳號，未輸入domain，

- 【5】 查看domain，判斷要往哪裡送
- 【6】 如登入成功，可以上網

# LAB用指令

- Vlan database
- Config t
- Interface vlan      interface fa0/X
- Switchport mode
- Switchport access vlan xx
- Switchport trunk allow vlan xx
- Ip add xx.xx.xx.xx    xx.xx.xx.xx    xx.xxx.xx.xx
- Ip route xx.xx.xx.xx xx.xx.xx.xx aa.aa.aa.aa



# LAB 2

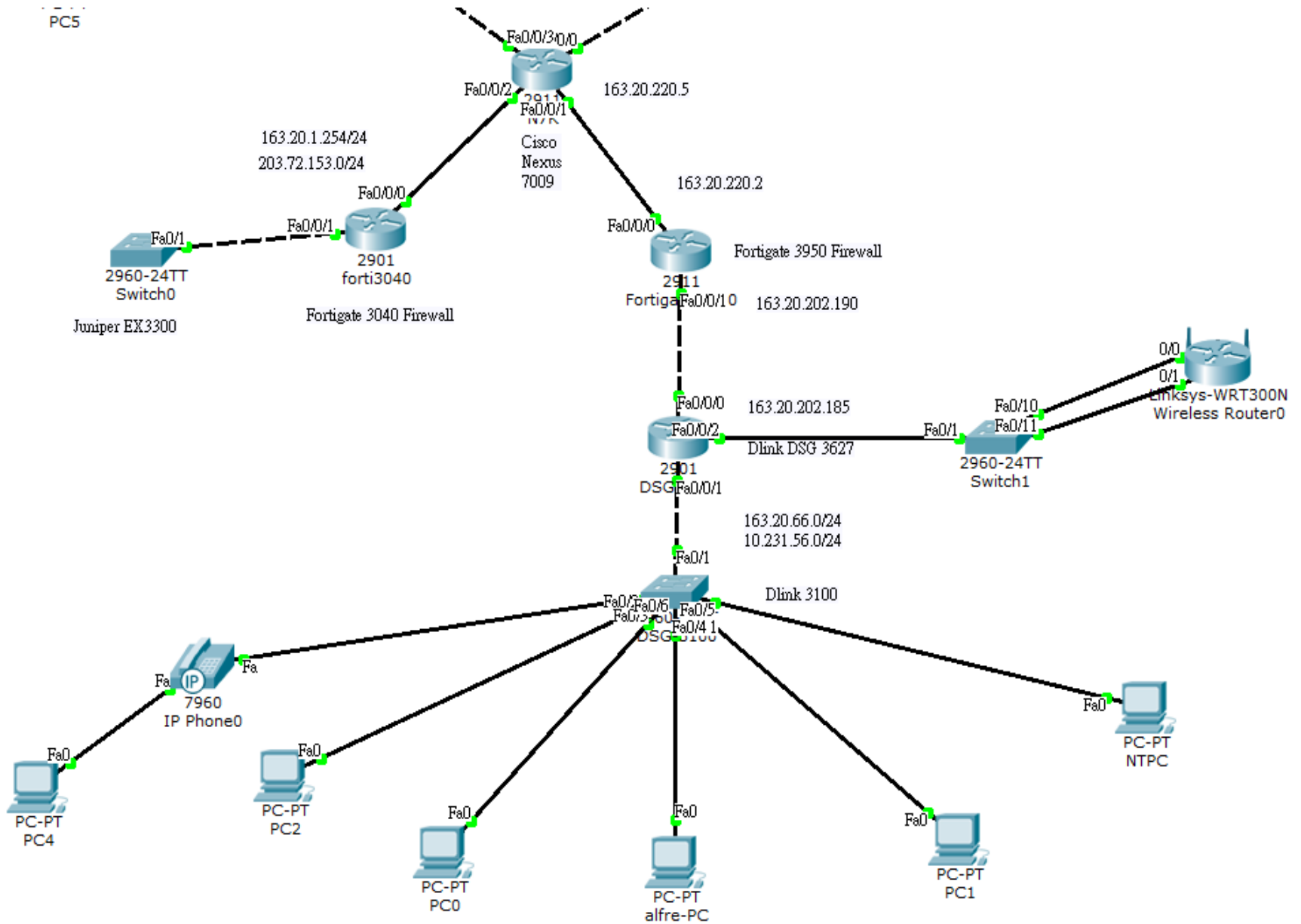

# Dlink MAC auth

- 1.Client 發出EAP封包
- 2.經L2由Vlan 36 引導至L3 Switch
- 3.L3收到MAC ，帶MAC帳號及變更後的密碼 ，向Radius發出認證請求。
- 4.認證通過 ， unblockPort
- 5.Client取得ip後上網。
- 6.Gateway在L3
- 建議設MAC設備：
  - 列表機 ， 無線ip phone手機....

# MAC認證架構圖

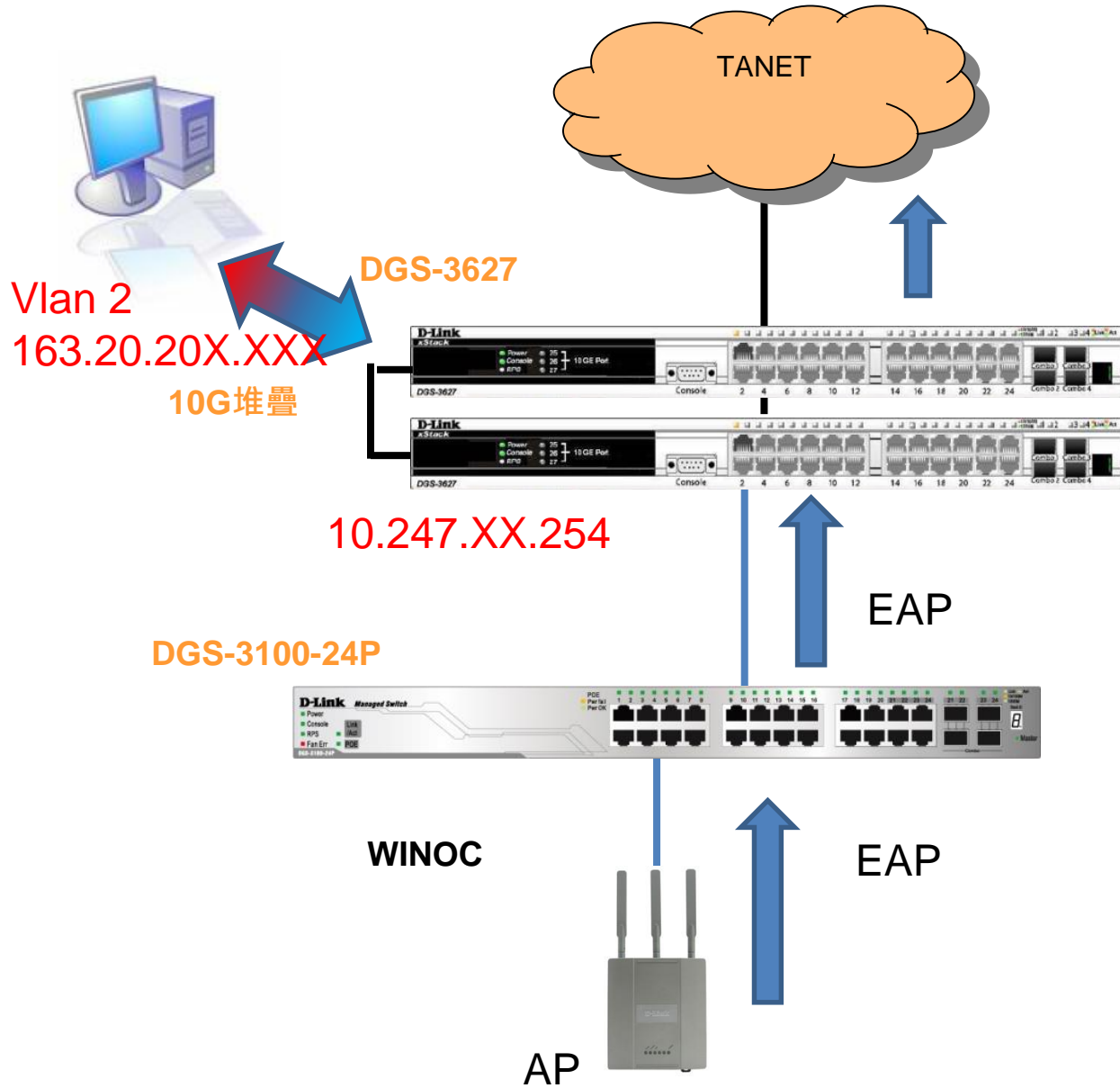

# Winoc設定設備radius key

- 中芳國小
- 厚德國小
- 建安國小
- 建國國小
- 後埔國小
- 思賢國小
- 恆毅中學
- 柑林國小
- 柑園國小
- 柑園國中
- 重陽國小
- 重慶國小
- 重慶國中
- 修德國小
- 埔墘國小
- 崁腳國小
- 時雨國中
- 桃子腳國中
- 泰山高中
- 泰山國小
- 泰山國中
- 海山高中
- 海山國小
- 烏來國中小
- 貢寮國小
- 貢寮國中
- 乾華國小
- 國立三重高中
- 國光國小
- 國泰國小
- 崇林國中
- 崇德國小
- 康橋國中小
- 教研中心
- 淡水商工
- 淡水國小
- 淡水國中
- 淡江高中
- 清水高中

設備設定 設備關聯性

### 修改單一設備設定

廠牌：	Fortinet
型號：	General Controller
類型：	AG
名稱：	FG-300C
設備編號：	100
設定成RADIUS客戶端？	<input checked="" type="radio"/> 是 <input type="radio"/> 否
RADIUS共用密碼：	[REDACTED]
DNS網域：	
IP位址：	163.20.202.186
HTTP埠號：	443
SNMP埠號：	0
TCP埠號：	23
UDP埠號：	0
MAC位址：	0
SNMP唯讀密碼：	[REDACTED]
SNMP讀寫密碼：	[REDACTED]
告警啟用狀態：	<input type="radio"/> 啟用 <input checked="" type="radio"/> 停用 <input type="radio"/> 略過健康檢查
描述：	
啟始網頁：	
地點座標：	X: 0 Y: 0 <span>圖形化選取座標</span>

以下設定如有變更，會寫入到設備中

修改設備：	<input checked="" type="radio"/> 管理網頁帳號密碼 <input type="radio"/> SSID <input type="radio"/> DNS <input type="radio"/> RADIUS
管理網頁帳號：	[REDACTED] <input checked="" type="checkbox"/> 不寫入到設備
管理網頁密碼：	[REDACTED]

確定 取消

來問的設備帶的source ip

# 新北市無線網路Mobile架構圖

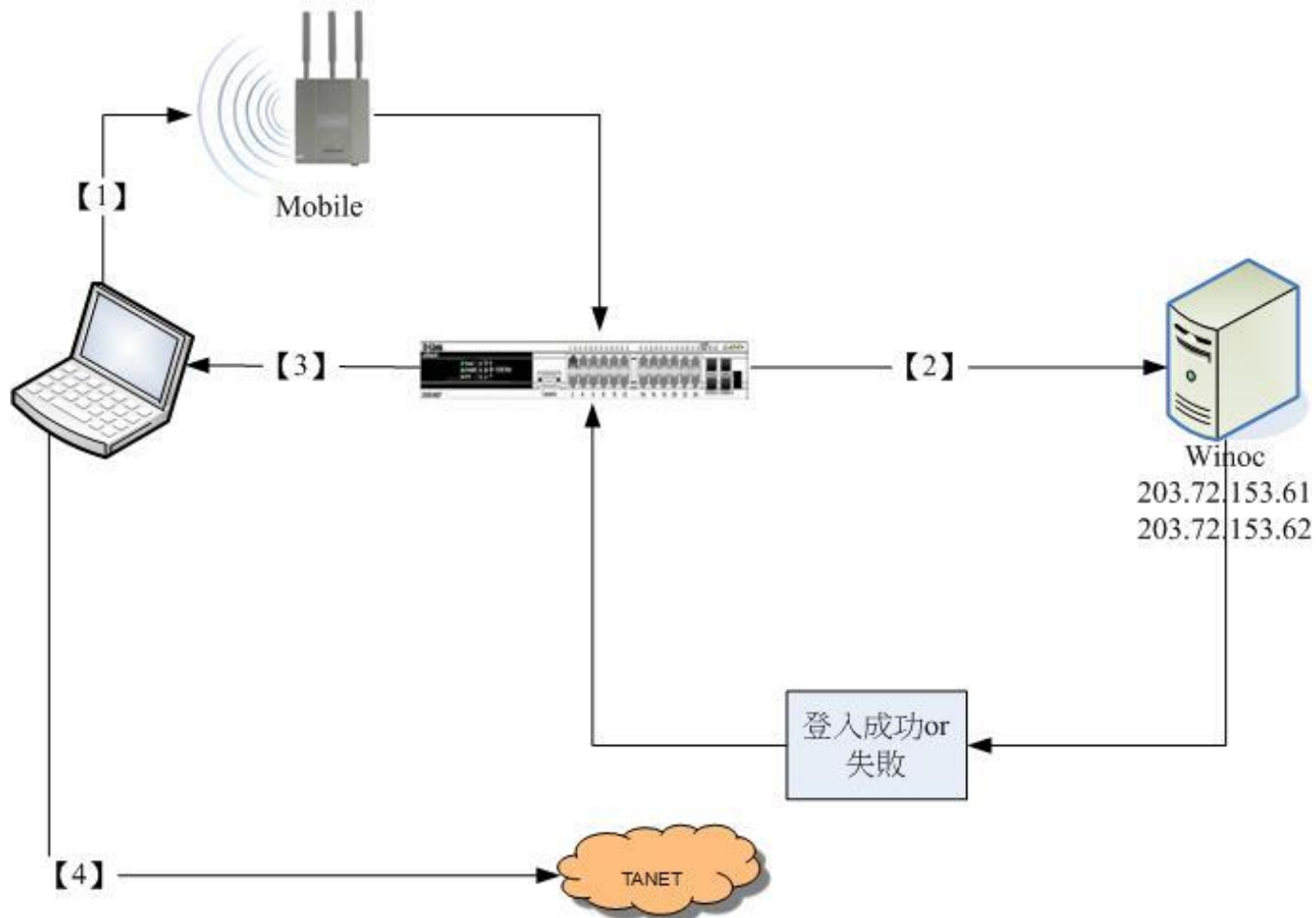

- 【1】 電腦連線Mobile
- 【2】 3627會送出電腦MAC及密碼0000
- 【3】 如登入成功取得10.247 or 10.248網段
- 【4】 開始上網

# WPA2 認證架構圖

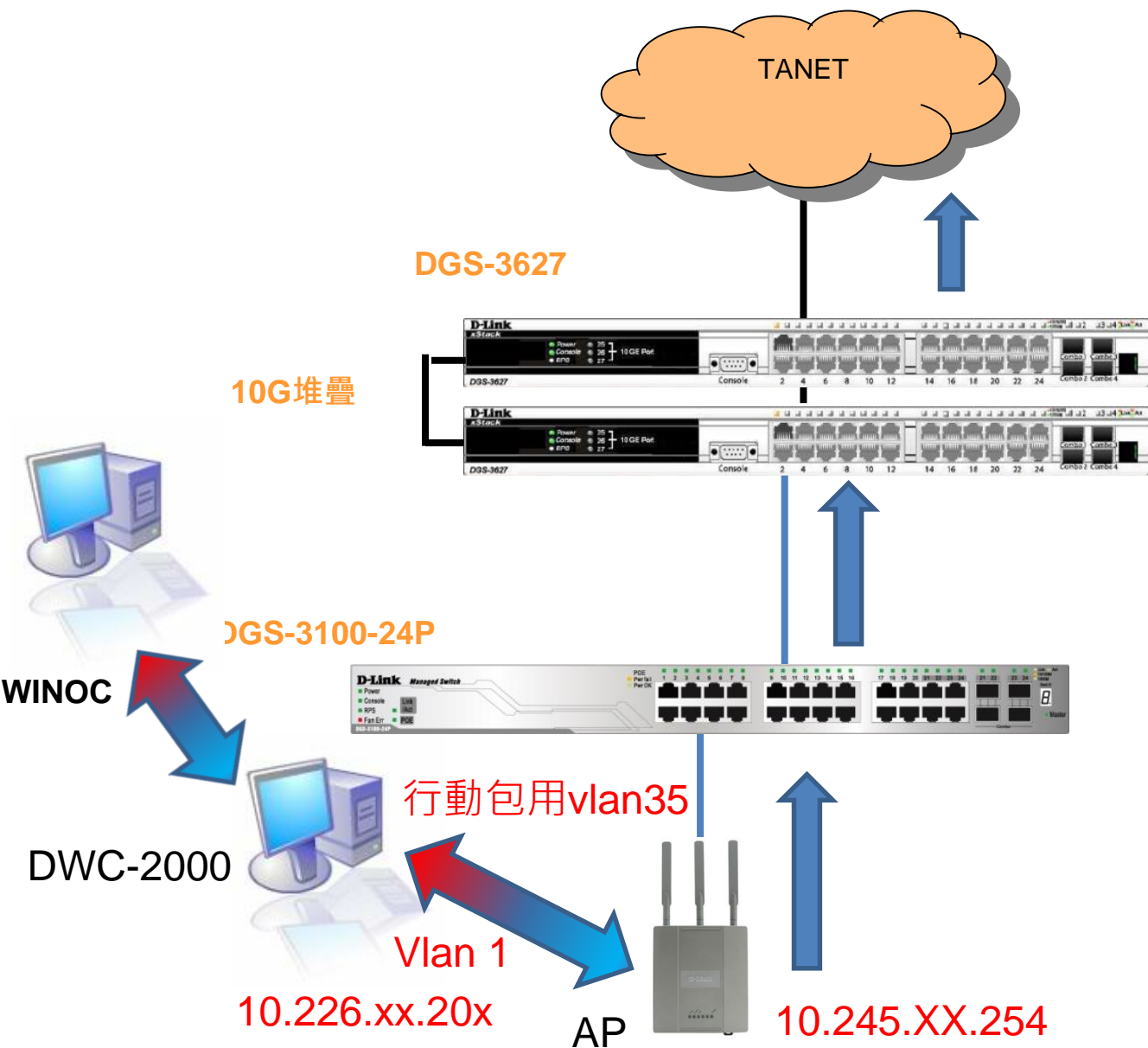

# WPA2認證行為

## 新北市無線網路WPA2架構圖

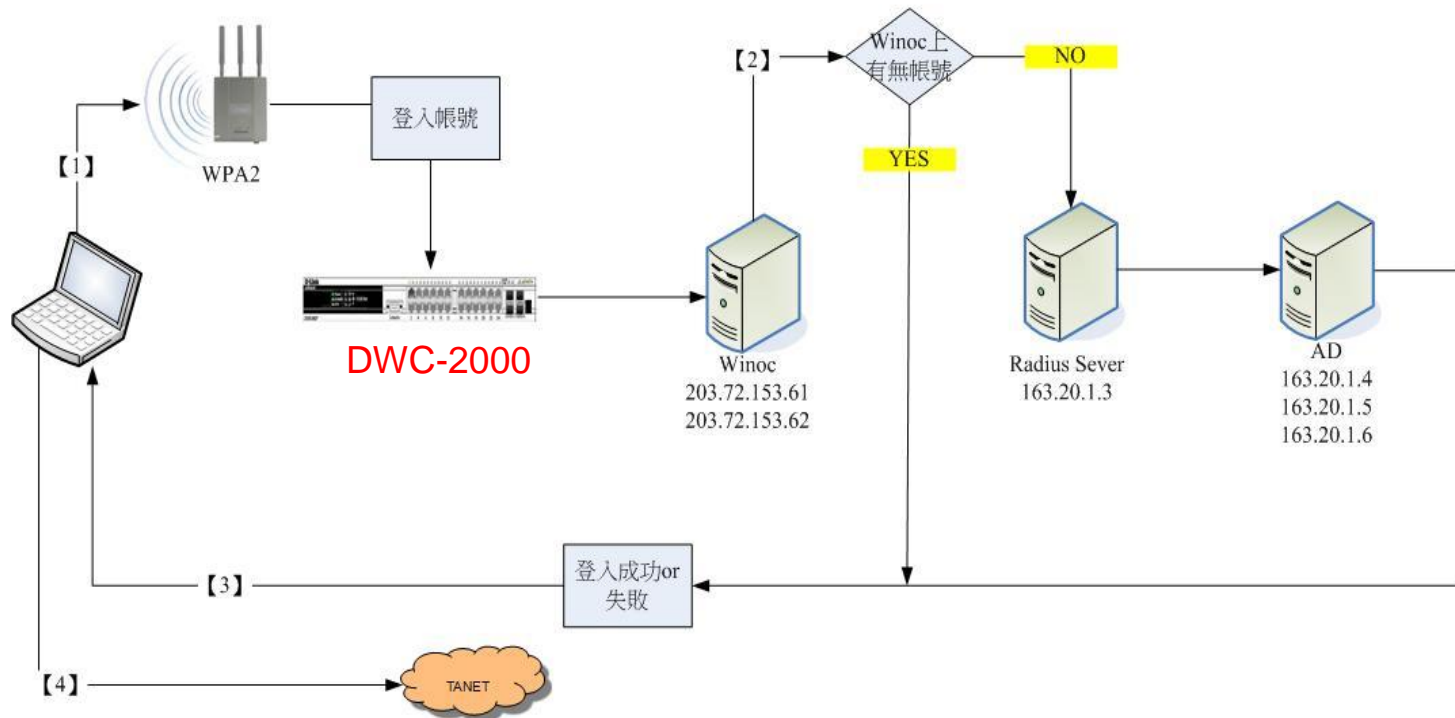

- 【1】 電腦連線WPA2，並輸入帳號密碼
- 【2】 Winoc檢查本身是否有帳號密碼
- 【3】 如登入成功取得10.245 or 10.246網段
- 【4】 開始上網

# Winoc設定設備radius key

- 中芳國小
- 厚德國小
- 建安國小
- 建國國小
- 後埔國小
- 思賢國小
- 恆毅中學
- 柑林國小
- 柑園國小
- 柑園國中
- 重陽國小
- 重慶國小
- 重慶國中
- 修德國小
- 埔墘國小
- 崁腳國小
- 時雨國中
- 桃子腳國中
- 泰山高中
- 泰山國小
- 泰山國中
- 海山高中
- 海山國小
- 烏來國中小
- 貢寮國小
- 貢寮國中
- 乾華國小
- 國立三重高中
- 國光國小
- 國泰國小
- 崇林國中
- 崇德國小
- 康橋國中小
- 教研中心
- 淡水商工
- 淡水國小
- 淡水國中
- 淡江高中
- 清水高中

設備設定 設備關聯性

### 修改單一設備設定

廠牌：	Fortinet
型號：	General Controller
類型：	AG
名稱：	FG-300C
設備編號：	100
設定成RADIUS客戶端？	<input checked="" type="radio"/> 是 <input type="radio"/> 否
RADIUS共用密碼：	[REDACTED]
DNS網域：	
IP位址：	163.20.202.186
HTTP埠號：	443
SNMP埠號：	0
TCP埠號：	23
UDP埠號：	0
MAC位址：	0
SNMP唯讀密碼：	[REDACTED]
SNMP讀寫密碼：	[REDACTED]
告警啟用狀態：	<input type="radio"/> 啟用 <input checked="" type="radio"/> 停用 <input type="radio"/> 略過健康檢查
描述：	
啟始網頁：	
地點座標：	X: 0 Y: 0 <span>圖形化選取座標</span>

以下設定如有變更，會寫入到設備中

修改設備：	<input checked="" type="radio"/> 管理網頁帳號密碼 <input type="radio"/> SSID <input type="radio"/> DNS <input type="radio"/> RADIUS
管理網頁帳號：	[REDACTED] <input checked="" type="checkbox"/> 不寫入到設備
管理網頁密碼：	[REDACTED]

確定 取消

來問的設備帶的source ip



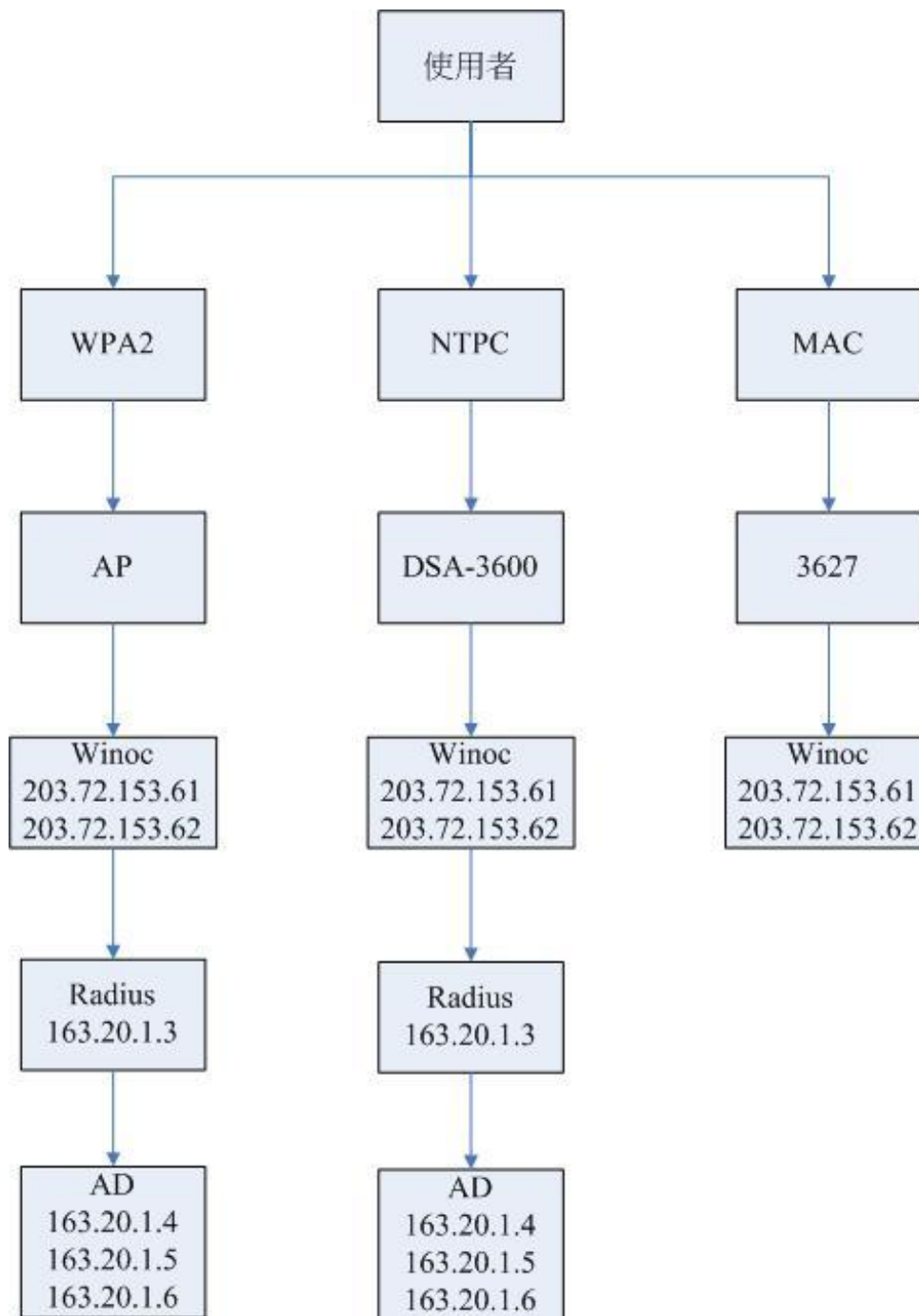

# AAA

- 認證(Authentication):Radius Server
- 授權(Authorization):FireWall
- 稽核(Audit)及報表功能:syslog
-

# Thin AP架構

- Thin AP的設計是遵循CAWAP(Control And Provisioning of Wireless Access Points)規範, 意味著AP本身的大多業務是交由上層AC來處理, CAWAP標準可以參考RFC-5415及RFC-5416文件:

# Thin AP架構圖

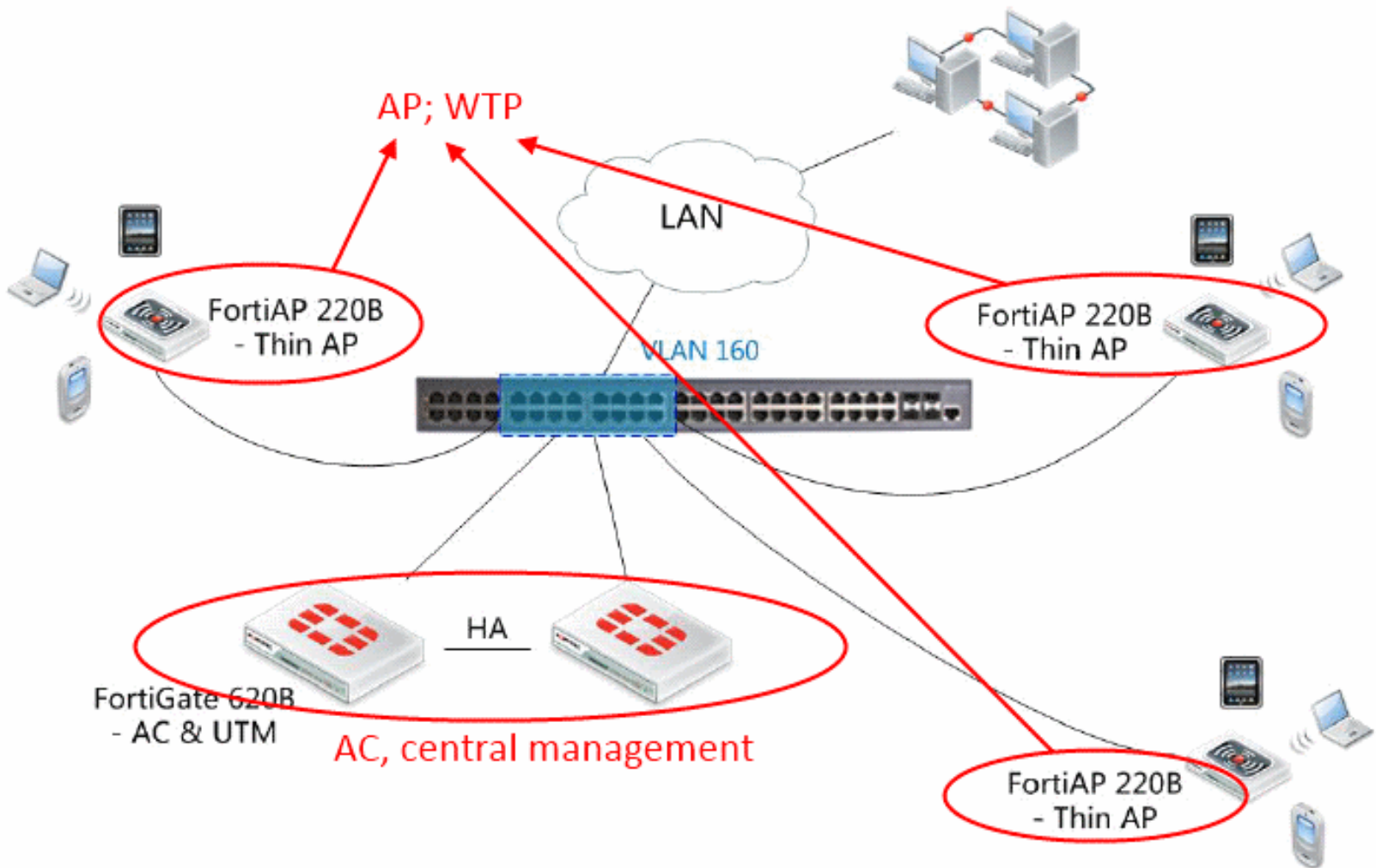

引用自[http://www.osslab.com.tw/Hardware/Router/FortiAP\\_220B\(Zero-config\)](http://www.osslab.com.tw/Hardware/Router/FortiAP_220B(Zero-config))

- 透過CAWAP的實作, ThinAP架構規劃了兩種實體設備類型, 負責不同的業務操作: AP(WTP)和AC.
  1. AP: Access Point, 即無線收發端本身, 通常僅是單純對無線數據(wireless frames)的收發送操作, 又稱WTP(\*).
  2. AC: Access Controller, 當AP傳送過來的數據, 將會轉交由AC單元進行處理, AC會乘載大多業務操作
- WTP: Wireless Termination Point

# Thin AP 啟動過程及其行為

- AP 開啟取得AP ip
  - 可以設定固定ip or DHCP自動取得ip
- AP以AP ip 當Souce ip連接AC
  - 因此AP ip網段須能與AC互通(Routing要能到)
- AP由AC取得config啟動AP設備
- AC 給予AP config設定中包含
  - 2.4G and 5G 訊號頻道設定
  - SSID設定(包含網段、名稱、認證方式)
- AC本身擔任：
  - Route Mode GW portal認證
  - Bride Mode data traffice monitor工作

# Thin AP架構細部文件參考

- IP不夠用處理方式，Client發B Class
- Firewall做NAT
- 設一個C做ip NAT Pool
- Policy管理存取權
- <http://www.pcdvd.com.tw/showthread.php?t=984768>



# SNGN校園無線網路簡介



# 行動包Thin AP架構

# 無線網路控制器設計

50

- 無線網路控制器透過vlan 8與 Dlink 3620做 routing
- AP取得config Source ip
  - 固定式走Vlan1
  - 行動包走Vlan35
- SSID NTPC GateWay在無線網路控制器
- SSID NTPC-Mobile GateWay在Dlink 3620
- SSID NTPC-WPA2 GateWay在Dlink 3620
  
- Data traffice 僅NTPC走無線網路控制器
- 無線網路控制器收集所有無線訊號log

# 行動包Thin 架構

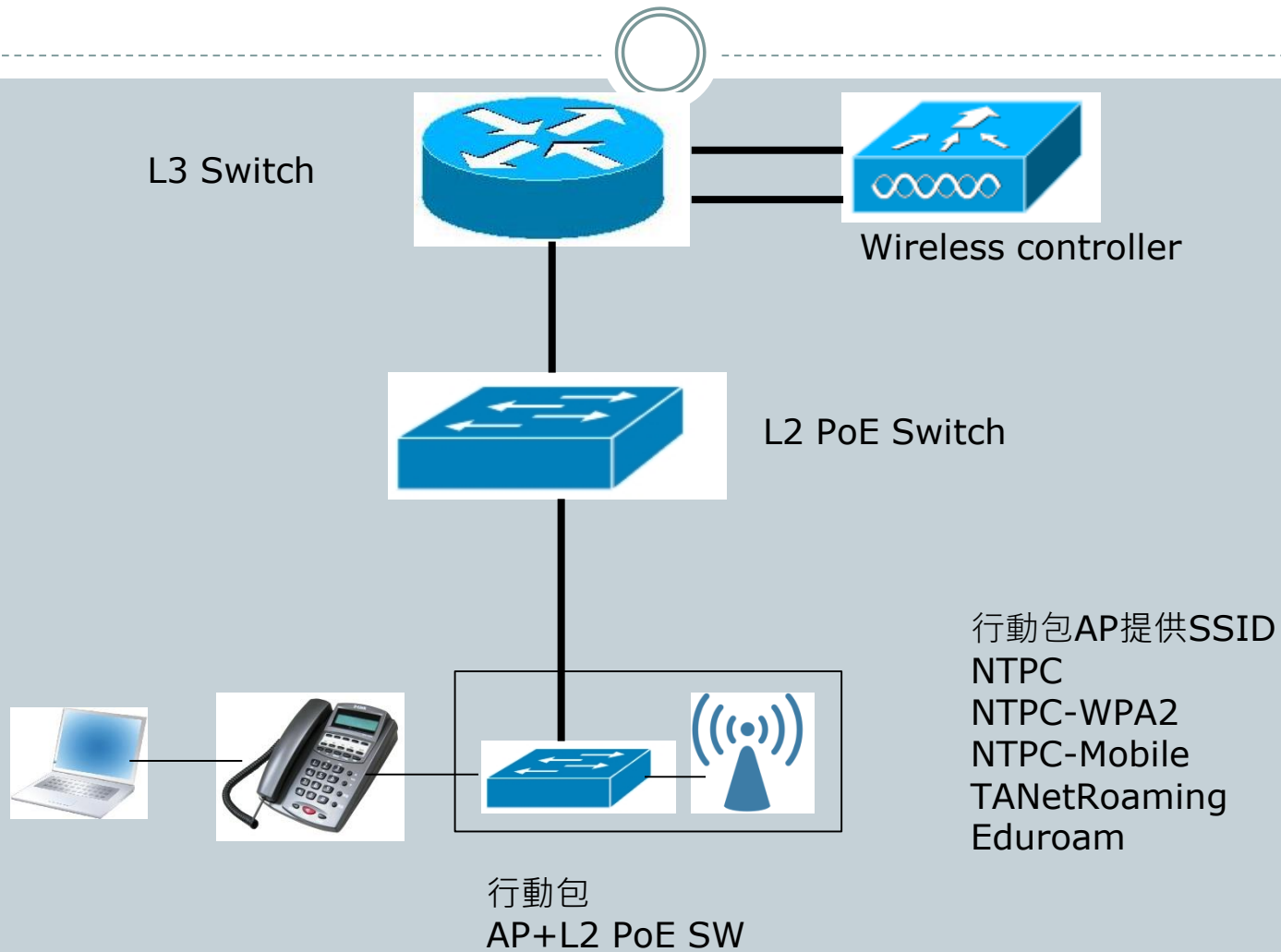

# 行動包架構說明



- 行動包無線AP透過行動包內的PoE switch供電
- 行動包的PoE Switch可以任意接上L2 PoE Switch的Port上,AP可以透過Vlan 35(WPA2)自動連回無線控制器上取得config及更新資訊!
- 行動包如果使用話機的網點,將可將話機接上PoE switch,後端電腦接於話機上,依然可以正常使用
- 行動包AP須提供5組SSID提供後端
  - NTPC(WEB認證)
  - NTPC-WPA2
  - NTPC-Mobile
  - TANetRoaming(NTPC)
  - Eduroam(NTPC-WPA2)

# 固定式Thin AP架構

# 固定式Thin AP架構

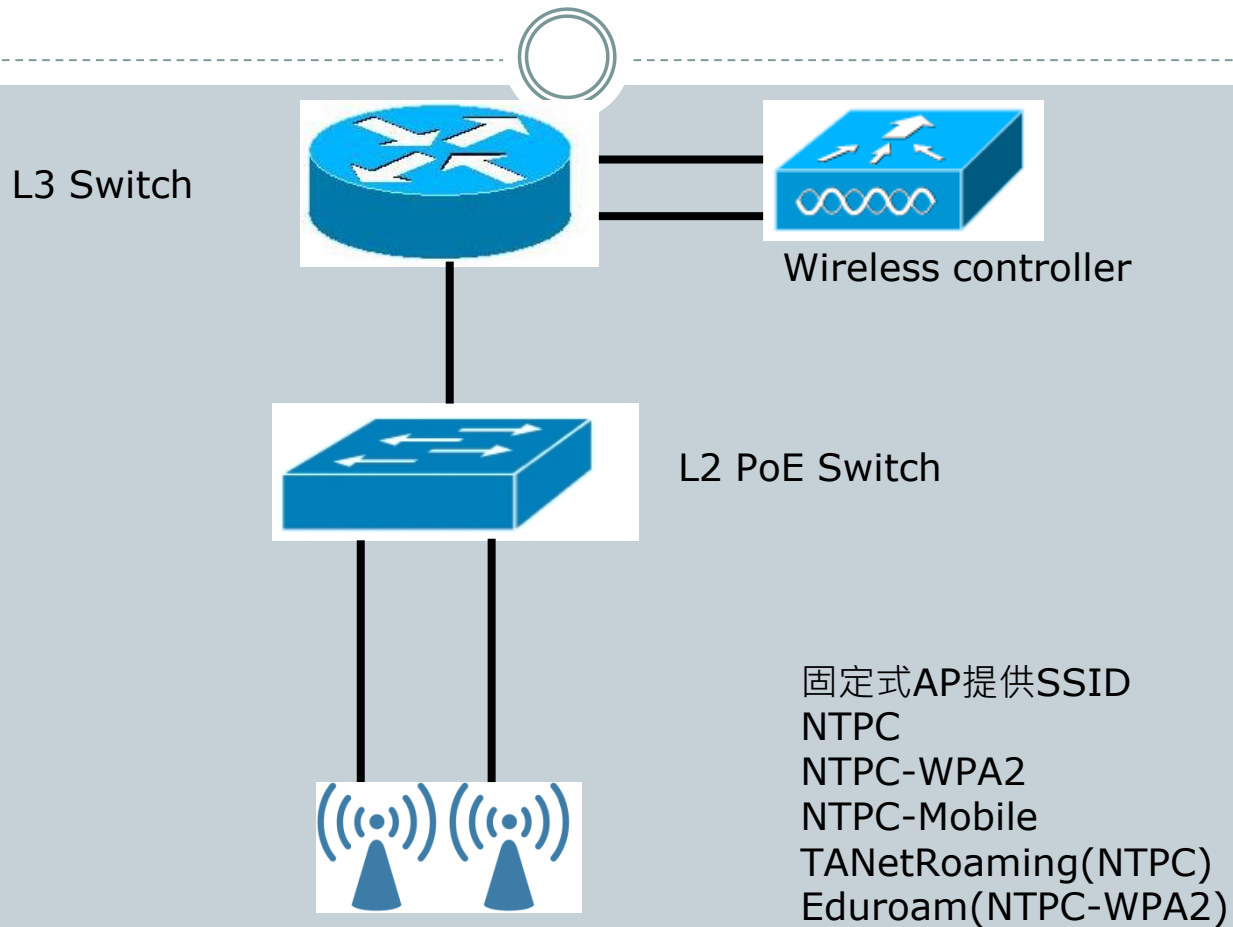

# 固定式架構說明



- 固定式無線AP透過L2 PoE switch供電
- 行動包的PoE Switch可以任意接上L2 PoE Switch的Port上,AP可以透過Vlan 1(Vlan MGT)自動連回無線控制器上取得config及更新資訊!
- 固定式無線AP建立5組SSID
  - NTPC(WEB認證)
  - NTPC-WPA2
  - NTPC-Mobile
  - TANetRoaming(NTPC)
  - Eduroam(NTPC-WPA2)
- 固定式無線AP由無線網路控制器進行控管,可統一配發設定資料與韌體升級等

# WEB認證-controller進行認證

WiNOC Server  
(Radius Server)



L3 Switch

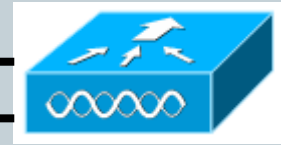

Wireless controller

L2 PoE Switch



WEB認證SSID  
NTPC  
TANetRoamin  
g

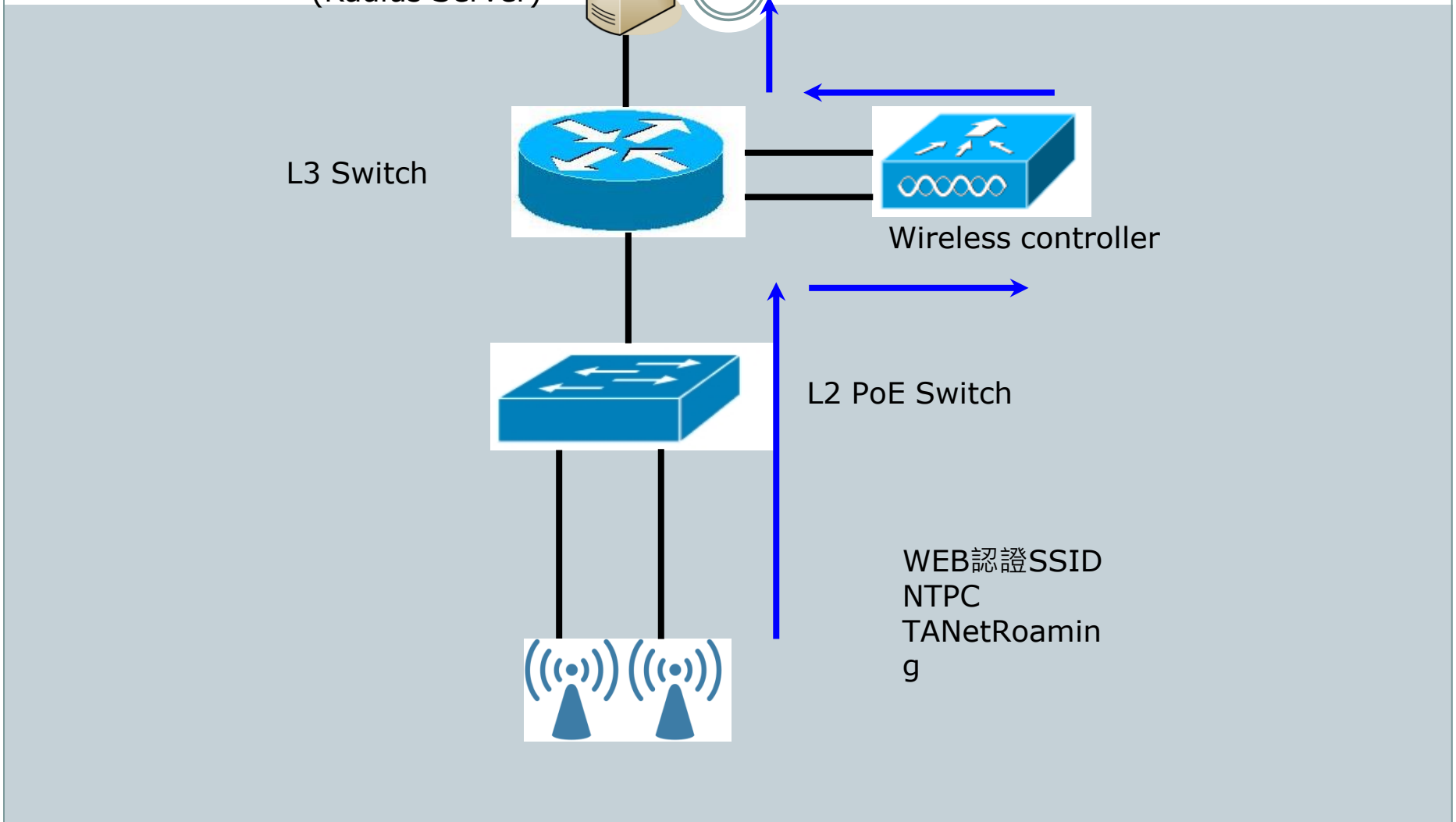



# 802.1x 認證-controller進行認證

WiNOC Server  
(Radius Server)



L3 Switch

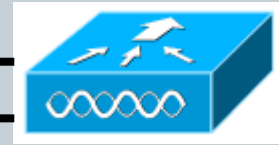

Wireless controller

L2 PoE Switch



802.1x認證SSID  
NTPC-WPA2  
Eduroam

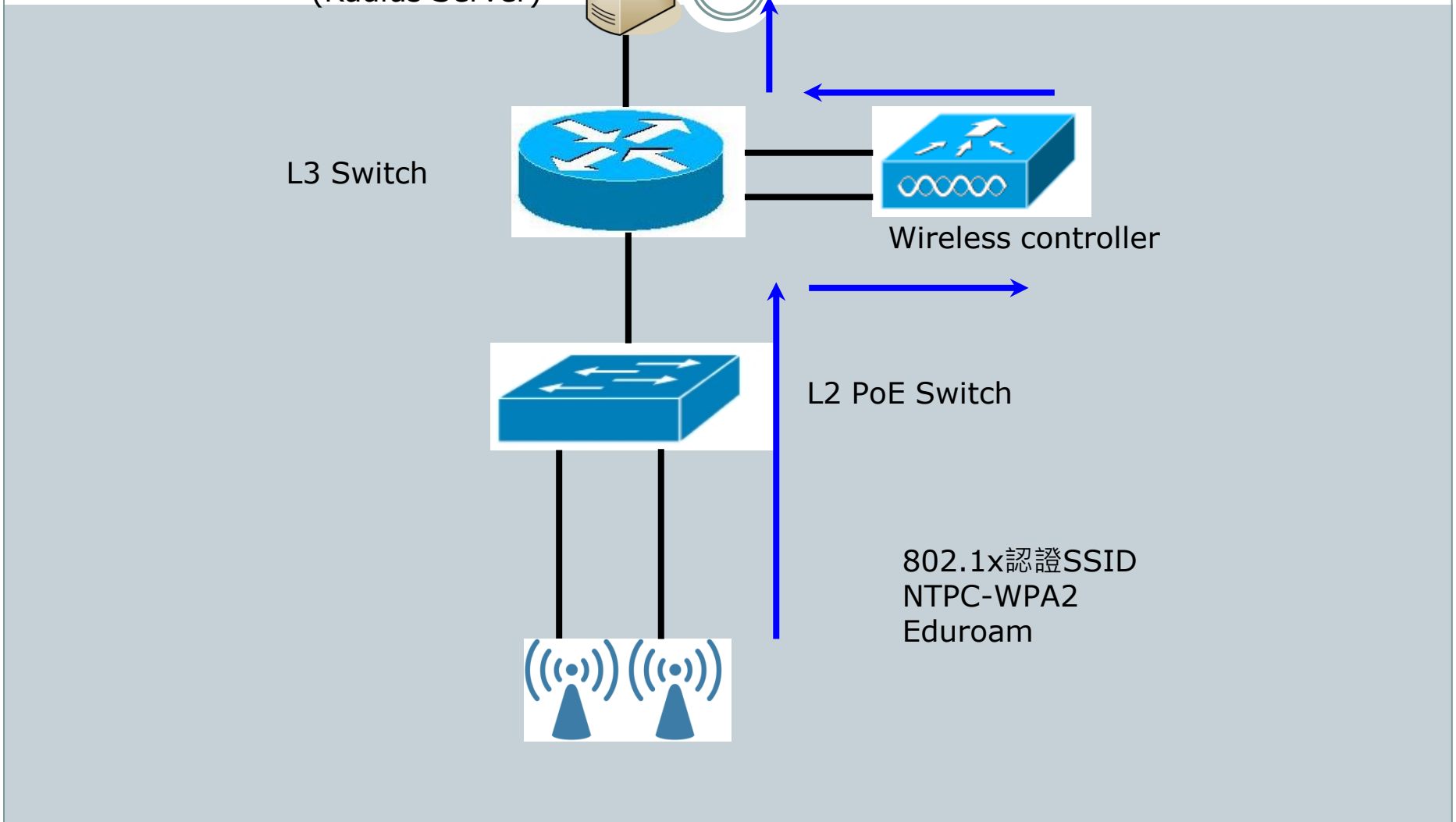

# MAC 認證-L3 switch進行認證

WiNOC Server  
(Radius Server)



L3 Switch



Wireless controller



L2 PoE Switch



MAC認證SSID  
NTPC-Mobile



# Thin AP controller設定及做法

59

- 將Linksys 的Lan接到需派發ip的 L2 vlan 該Vlan即可取得該vlan網段ip
- 將WPA2及Mobile GW設在 L3 switch
- NTPC GW設在 AC controller
- 將AC controller與L3 switch間設定vlan8 ，並將 vlan 30 路由透過vlan8送到L3 switch
- L3 switch將vlan30網段 route送至AC的vlan8 wan interface 即可完成路由設定。

# AC Controller interface vlan設定

60

The screenshot displays the D-Link Unified Controller web interface. At the top, the D-Link logo and 'Unified Controller - DWC 2000' are visible. The user is logged in as 'admin (ADMIN)' with a 'Logout' button. System information includes 'Serial Number: S3391F500009', 'Firmware Version: 4.4.0.3\_B917\_WW', and 'Language: English [US]'. A search bar and a 'Wizard' icon are also present. The main navigation menu includes 'Status', 'Wireless', 'Network', 'Security', and 'Maintenance'. The current page is 'Status >> Network Information >> Interfaces'. A note states: 'The profiled and packet traffic through the controller is displayed for each interface..'. Below this, the 'Interfaces' section is titled, followed by 'LAN info' which contains a table of network statistics for LAN 1 through LAN 4. The 'VLAN info' section shows a table of VLAN configurations with columns for VLAN name, Incoming, Outgoing, Dropped In, and Dropped Out traffic.

Logged in as: admin ( ADMIN ) [Logout](#)

Serial Number: S3391F500009 | Firmware Version: 4.4.0.3\_B917\_WW | Language: English [US]

Wizard System Search...

Status Wireless Network Security Maintenance

Status » Network Information » Interfaces

The profiled and packet traffic through the controller is displayed for each interface..

### Interfaces

#### LAN info

Description	LAN 1	LAN 2	LAN 3	LAN 4
Incoming Packets / Bytes	8258600 / 3GB	---	---	---
Outgoing Packets / Bytes	5196897 / 1GB	---	---	---
Dropped In Packets / Bytes	0 / 0B	---	---	---
Dropped Out Packets / Bytes	0 / 0B	---	---	---

#### VLAN info

Show 10 entries [This information is view only]

VLAN	Incoming [Packets / Bytes]	Outgoing [Packets / Bytes]	Dropped In [Packets / Bytes]	Dropped Out [Packets / Bytes]
Mobile	0 / 0B	10 / 856B	0 / 0B	0 / 0B
NTPC	2941132 / 188MB	2742016 / 1GB	0 / 0B	0 / 0B
WPA2	0 / 0B	10 / 876B	0 / 0B	0 / 0B

## Network » VLAN » VLAN Settings



The controller supports virtual network isolation on the LAN with the use of VLANs. LAN devices can be configured to communicate in a subnetwork defined by VLAN identifiers.

## VLAN List

Show  entries [Right click row to see more options]

Name	VLAN ID	VLAN Type	IP Address	Subnet Mask	Captive Portal	Authentication Server
Default	1	VLAN (L3)	10.253.88.1	255.255.255.0	Free	None
Moblie	36	VLAN (L3)	NA	NA	NA	NA
NTPC	30	VLAN (L3)	10.251.88.254	255.255.255.0	External CP Web	radius
WPA2	35	VLAN (L3)	NA	NA	NA	NA

Showing 1 to 4 of 4 entries

First Previous 1 Next Last

Add New VLAN

The LAN Configuration page allows you to configure the LAN interface of the controller including the DHCP Server which runs on it and Changes here affect all devices connected to the controller's LAN switch and also wireless LAN clients. Note that a change to the LAN IP address will require all LAN hosts to be in the same subnet and use the new address to access this GUI.

## LAN Settings

### IP Address Setup

IP Address Subnet Mask 

### DHCP Setup

DHCP Mode Domain Name 

### Default Route

Enable Default Route Gateway DNS Server SNAT  OFF

# AP上SSID狀態

DAP-2590

- Basic Settings
- Advanced Settings
- Status

## Multi-SSID Settings

Enable Multi-SSID     Enable Priority

**Wireless Settings**

Band: 2.4 GHz  
Index: Primary SSID  
SSID: TPC  
SSID Visibility: Enable  
Security: Open System  
Priority: 0  
WMM (Wi-Fi Multimedia): Enable

**Key Settings**

Encryption:  Disable     Enable  
Key Type: HEX    Key Size: 64 Bits  
Key Index(1~4): 1  
Network Key:   
Confirm Key:

[Add](#)

Index	SSID	Band	Encryption	Delete
Primary SSID	TPC	2.4 GHz	None	
<a href="#">Multi-SSID1(Edit)</a>	TPC-WPA2	2.4 GHz	WPA2-Auto-Enterprise	
<a href="#">Multi-SSID2(Edit)</a>	TPC-Mobile	2.4 GHz	None	

# AP Vlan設定

The screenshot displays the configuration page for a DWL-3200AP. The left sidebar shows a navigation tree with categories like Basic Settings, Advanced Settings, DHCP Server, Filters, and Status. The main area is titled 'Multi-SSID Settings' and contains two sections: 'Wireless Settings' and 'RADIUS Server Settings'. The 'Wireless Settings' section includes fields for Band (IEEE802.11g), Index (Primary SSID), Wireless Network Name (SSID) (NTPC-WPA2), SSID Broadcast (Enable), Security (WPA2-Enterprise), VLAN Tag Mode (Manual), VLAN ID (35), Priority (0), and WMM (Enable). The 'RADIUS Server Settings' section includes fields for Cipher Type (AUTO), Group Key Update Interval (1800 Sec), RADIUS Server (203.72.153.61), RADIUS Port (1812), RADIUS Secret (masked), Accounting Mode (Enable), Accounting Server (203.72.153.61), and Accounting Port (1813). An 'Apply' button is located at the bottom right of the configuration area. Below the configuration fields is a table showing the current configuration for three SSIDs: Primary, Multi-SSID1, and Multi-SSID2. The 'VLAN ID' column in this table is highlighted with a red box.

Index	SSID	Band	Encryption	VLAN ID	Delete
Primary	NTPC-WPA2	11g	WPA2-Enterprise	35	
Multi-SSID1	NTPC	11g	OFF	30	Delete
Multi-SSID2	NTPC-Mobile	11g	OFF	36	Delete



# Winoc教學 ntpc-Mobile

如不知帳密可來電至教研中心詢問:分機531,532

The screenshot displays the Winoc Wireless Network Operations Center interface. The main content area is titled "組織與使用者管理" (Organization and User Management). It includes sections for "組織: 直潭國小" (Organization: Zhitun Elementary School) and "使用者帳號命令" (User Account Commands). The "使用者帳號命令" section contains search criteria and a list of users.

全選	帳號	可用時數	有效期限	管理員	狀態						
<input type="checkbox"/>	guestes0001	無限制	永久	a2532301	停用	啟用	刪除	修改...	記錄...	事件...	報表...
<input type="checkbox"/>	guestes0002	無限制	永久	a2532301	停用	啟用	刪除	修改...	記錄...	事件...	報表...
<input type="checkbox"/>	guestes0003	無限制	永久	a2532301	停用	啟用	刪除	修改...	記錄...	事件...	報表...
<input type="checkbox"/>	guestes0004	無限制	永久	a2532301	停用	啟用	刪除	修改...	記錄...	事件...	報表...
<input type="checkbox"/>	guestes0005	無限制	永久	a2532301	停用	啟用	刪除	修改...	記錄...	事件...	報表...
<input type="checkbox"/>	guestes0006	無限制	永久	a2532301	停用	啟用	刪除	修改...	記錄...	事件...	報表...
<input type="checkbox"/>	guestes0007	無限制	永久	a2532301	停用	啟用	刪除	修改...	記錄...	事件...	報表...
<input type="checkbox"/>	guestes0008	無限制	永久	a2532301	停用	啟用	刪除	修改...	記錄...	事件...	報表...
<input type="checkbox"/>	guestes0009	無限制	永久	a2532301	停用	啟用	刪除	修改...	記錄...	事件...	報表...
<input type="checkbox"/>	guestes0010	無限制	永久	a2532301	停用	啟用	刪除	修改...	記錄...	事件...	報表...

WiNOC - Wired/Wireless Network Operations Center - Windows Internet Explorer

http://203.72.153.61/winoc/public/

Ver. 2.0.3877.22540 繁體中文

Wireless Network Operations Center

首頁 | 服務地點 | 忘記密碼? | 登出

開始 | 使用者總管 | 即時狀態監控 | 個人資料修改 | 登出

### 使用者總管

新增單一使用者

姓名：	張小棠
帳號：	00251167953F
密碼：	●●●●
狀態：	<input checked="" type="radio"/> 啟用 <input type="radio"/> 停用
可用時數：	<input checked="" type="radio"/> 無限制 <input type="radio"/> 10小時 <input type="radio"/> 20小時 <input type="radio"/> 30小時 <input type="radio"/> 40小時 <input type="radio"/> 50小時 <input type="radio"/> [ ] 分鐘
有效期限：	<input checked="" type="radio"/> 無限制 <input type="radio"/> 當天 <input type="radio"/> 1天後 <input type="radio"/> 1週後 <input type="radio"/> 1個月後 <input type="radio"/> [ ] 天後 <input type="radio"/> [ ] 週後 <input type="radio"/> [ ] 個月後 <input type="radio"/> 到 [ ] 年 [ ] 月 [ ] 日
類型：	MAC
電子郵件：	[ ]
電話號碼：	[ ]
備註：	[ ]
頻寬(下載/上傳)：	無限制 / 無限制

確認 取消

AddUser.aspx

網路網路 | 受保護模式: 關閉 | 100%

# Ntpc-Mobile 除錯ARP Table

L3透過Winoc做認證,由L3決定是否放行unBlockByMACAuth

The screenshot displays a network management interface with a sidebar on the left and a main content area on the right. The sidebar contains a tree view of navigation options, including 'Routing Table', 'Browse IP Multicast Forwarding Table', 'Browse IP Multicast Interface Table', 'Browse IGMP Group Table', 'DVMRP Monitor', 'PIM Monitor', 'OSPF Monitor', 'Switch Logs', 'Browse ARP Table', 'MAC-based Access Control List', 'Reset', 'Reboot System', 'Save Services', and 'Logout'. The main content area shows the 'MAC Address Table' with a title bar and two buttons: 'View All Entries' and 'Clear All Entries'. The table has six columns: VID, VLAN Name, MAC Address, Unit, Port, and Type. The data rows show various entries, including several 'BlockByMACAuth' entries for VLAN 36.

VID	VLAN Name	MAC Address	Unit	Port	Type
30	wlan	20-64-32-04-49-16	1	24	Dynamic
30	wlan	28-98-7B-7D-26-D4	1	23	Dynamic
30	wlan	34-51-C9-8A-55-8E	1	23	Dynamic
30	wlan	38-AA-3C-E1-C9-12	1	20	Dynamic
30	wlan	5C-B5-24-DE-35-C4	1	23	Dynamic
30	wlan	64-A7-69-E0-10-FF	1	23	Dynamic
30	wlan	70-73-CB-6B-28-1C	1	24	Dynamic
30	wlan	7C-11-BE-61-6A-B0	1	22	Dynamic
30	wlan	7C-D1-C3-F8-43-C5	1	23	Dynamic
30	wlan	84-00-D2-D0-AD-ED	1	23	Dynamic
30	wlan	88-30-8A-25-53-7D	1	23	Dynamic
30	wlan	D8-A2-5E-B4-A4-D6	1	24	Dynamic
30	wlan	E8-06-88-73-5D-18	1	20	Dynamic
35	wpa2	00-21-91-A5-7B-07	CPU		Self
35	wpa2	00-26-5A-C2-95-9B	1	23	Dynamic
36	mac_auth	00-21-91-A5-7B-08	CPU		Self
36	mac_auth	00-24-2B-09-30-02	1	23	BlockByMACAuth
36	mac_auth	00-26-5A-C2-95-9B	1	23	BlockByMACAuth
36	mac_auth	1C-B0-94-19-C5-C8	1	22	BlockByMACAuth
36	mac_auth	50-EA-D6-7F-89-8F	1	20	BlockByMACAuth

Previous

# Ntpc-WPA2 Debug

The screenshot displays the configuration page for a DWL-3200AP, specifically the Multi-SSID Settings. The interface is divided into several sections:

- Navigation Tree (Left):** Shows a hierarchy of settings including Basic Settings (Wireless, LAN), Advanced Settings (Performance, Grouping, Multi-SSID, Rogue AP), DHCP Server, Filters, Status, and Log.
- Multi-SSID Settings (Main Area):**
  - Global Settings:**  Enable Multi-SSID,  Enable VLAN State,  Enable Priority.
  - Wireless Settings:** Band (IEEE802.11g), Index (Primary SSID), Wireless Network Name (SSID) (NTPC-WPA2), SSID Broadcast (Enable), Security (WPA2-Enterprise), VLAN Tag Mode (Manual), VLAN ID (35), Priority (0), WMM (Enable).
  - RADIUS Server Settings:** Cipher Type (AUTO), Group Key Update Interval (1800) Sec, RADIUS Server (203.72.153.61), RADIUS Port (1812), RADIUS Secret (masked), Accounting Mode (Enable), Accounting Server (203.72.153.61), Accounting Port (1813).
- Apply Button:** Located at the bottom right of the configuration area.
- Table:** A table at the bottom lists existing SSIDs with their respective configurations.

Index	SSID	Band	Encryption	VLAN ID	Delete
Primary	NTPC-WPA2	11g	WPA2-Enterprise	35	
Multi-SSID1	NTPC	11g	OFF	30	Delete
Multi-SSID2	NTPC-Mobile	11g	OFF	36	Delete

# 各校AP IP配置

- 10.226.x.201-205
- or
- 10.227.x.201-205

The screenshot displays the configuration page for a DWL-3200AP. The left sidebar shows a tree view with categories like Basic Settings, Advanced Settings, DHCP Server, Filters, and Status. The main content area is titled 'Multi-SSID Settings' and includes the following sections:

- Wireless Settings:** Includes checkboxes for 'Enable Multi-SSID', 'Enable VLAN State', and 'Enable Priority'. Fields include Band (IEEE802.11g), Index (Primary SSID), Wireless Network Name (SSID) (NTPC-WPA2), SSID Broadcast (Enable), Security (WPA2-Enterprise), VLAN Tag Mode (Manual), VLAN ID (35), Priority (0), and WMM (Enable).
- RADIUS Server Settings:** Includes fields for Cipher Type (AUTO), Group Key Update Interval (1800 Sec), RADIUS Server (203.72.153.61), RADIUS Port (1812), RADIUS Secret (masked), Accounting Mode (Enable), Accounting Server (203.72.153.61), and Accounting Port (1813).

An 'Apply' button is located at the bottom right of the configuration area. Below the configuration fields is a table summarizing the SSID configurations:

Index	SSID	Band	Encryption	VLAN ID	Delete
Primary	NTPC-WPA2	11g	WPA2-Enterprise	35	
Multi-SSID1	NTPC	11g	OFF	30	Delete
Multi-SSID2	NTPC-Mobile	11g	OFF	36	Delete

# Routing Table

Add

## IPv4 Static/Default Route Settings

IP Address	Subnet Mask	Gateway	Metric	Protocol	Backup	Weight	Status	Delete
0.0.0.0	0.0.0.0	163.20.209.182	1	Default	Primary	None	Active	<input type="checkbox"/>
10.252.29.0	255.255.255.0	10.254.29.1	1	Static	Primary	None	Active	<input type="checkbox"/>

Total Entries: 2

# 監控除錯

# 提供設備項目 - L2 POE交換器

## L2 POE交換器

### ➤ 提供高擴充性

- 提供實體堆疊功能

### ➤ 整合多元化網路應用

- 提供IPv6 MLD Snooping、QoS及ACL機制

### ➤ 提供穩定安全網路連線

- 實測每埠皆滿足網路電話及無線基地台所需電力

### ➤ 節能減碳

- 搭配WiNOC排程功能可自動開啟或關閉POE無線基地台或POE網路電話，以節省電費



**DGS-3100-24P/48P**



# L2基礎操作及簡易故障排除

# 設備狀態

The screenshot displays the web management interface for a D-Link DGS-3100-24P switch. The top navigation bar includes a 'Save' button, a 'Tools' dropdown menu, and a 'Stack ID' field. The main content area is divided into two sections: 'Device Information' and 'Device Status and Quick Configurations'. The 'Device Information' section provides details about the switch's hardware and system settings, while the 'Device Status and Quick Configurations' section lists various network features and their current status, with links to configure each feature.

**Device Information**

Device Type	DGS-3100-24P ST		
System Contact			
System Name	maes-L2-2	MAC Address	00-26-5a-c0-73-40
System Location		IP Address	10.227.29.102
Firmware Version	3.00.43	Subnet Mask	255.255.255.0
Hardware Version	a1	Default Gateway	10.227.29.254
Serial Number	F3E219C000083(unit 1)	Login Timeout (minutes)	10
System Time	10/05/2010		
System Up Time	108 days 10 hours 5 mins 20 seconds		
Boot version	1.0.1.04		

**Device Status and Quick Configurations**

Time Source	SNTP <a href="#">setting</a>	Jumbo Frame	Disabled <a href="#">setting</a>
802.1D Spanning Tree	Enabled <a href="#">setting</a>	BPDU Forwarding	Disabled <a href="#">setting</a>
DHCP Client	Disabled <a href="#">setting</a>	IGMP Snooping	Disabled <a href="#">setting</a>
Safeguard Engine	Enabled <a href="#">setting</a>	MLD Snooping	Disabled <a href="#">setting</a>
SNMP Trap	Enabled <a href="#">setting</a>	Broadcast Storm Control	Disabled <a href="#">setting</a>
SSL	Disabled <a href="#">setting</a>	802.1x Status	Disabled <a href="#">setting</a>
Asymmetric VLAN	Disabled <a href="#">setting</a>	GVRP Setting	Disabled <a href="#">setting</a>
VLAN Trunking	Disabled <a href="#">setting</a>	SSH	Disabled <a href="#">setting</a>
Telnet Setting	Enabled <a href="#">setting</a>	Port Mirroring	Disabled <a href="#">setting</a>

# Vlan 資訊

802.1Q VLAN					
VLAN List			Add/Edit VLAN		
VID	VLAN Name	Untag VLAN Ports	Tag VLAN Ports	Forbidden VLAN Ports	
1	default	1:24, 2:5, 2:23, 2:24, T1-T32			Edit Delete VID
5	lan	1:12	1:24		Edit Delete VID
10	intra-1		1:24		Edit Delete VID
20	Intra-2	1:1-1:11, 1:13-1:23, 2:1-2:4, 2:6-2:22	1:24		Edit Delete VID
25	voip		1:1-1:24, 2:1-2:24		Edit Delete VID
30	wlan		1:24, 2:5, 2:23, 2:24		Edit Delete VID
35	wpa2		1:24, 2:5, 2:23, 2:24		Edit Delete VID
36	mac_auth		1:24, 2:5, 2:23, 2:24		Edit Delete VID

Back Next

# PoE資訊

**PoE Port Setting**

Unit:  From Port:  To Port:  PoE Enable:  Power limit:   (W)

**Note :** The max power output of Class 0 is 15.4W, Class 1 is 4W, Class 2 is 7W, Class 3 is 15.4W.

Port	PoE Enable	Power limit	Power(W)	Voltage(V)	Current(mA)	Classification	Statu
2:1	Enabled	15.4	0	0	0	Class 0	search
2:2	Enabled	15.4	0	0	0	Class 0	search
2:3	Enabled	15.4	0	0	0	Class 0	search
2:4	Enabled	15.4	0	0	0	Class 0	search
2:5	Enabled	15.4	9.2	50.7	181	Class 3	deliveringl
2:6	Enabled	15.4	0	0	0	Class 0	search
2:7	Enabled	15.4	0	0	0	Class 0	search
2:8	Enabled	15.4	0	0	0	Class 0	search
2:9	Enabled	15.4	0	0	0	Class 0	search
2:10	Enabled	15.4	0	0	0	Class 0	search
2:11	Enabled	15.4	0	0	0	Class 0	search
2:12	Enabled	15.4	0	0	0	Class 0	search
2:13	Enabled	15.4	0	0	0	Class 0	search
2:14	Enabled	15.4	0	0	0	Class 0	search
2:15	Enabled	15.4	0	0	0	Class 0	search
2:16	Enabled	15.4	0	0	0	Class 0	search
2:17	Enabled	15.4	0	0	0	Class 0	search
2:18	Enabled	15.4	0	0	0	Class 0	search
2:19	Enabled	15.4	0	0	0	Class 0	search

# Log

## System Log

ID	Time	Log Description
1	10-May-2010 21:28:26	%AAA-I-CONNECT: New http connection for user admin, source 203.72.153.57 destination 10.227.29.102 ACCEPTED
2	10-May-2010 21:27:44	%AAA-I-DISCONNECT: http connection for user admin, source 203.72.153.57 destination 10.227.29.102 TERMINATED
3	10-May-2010 21:12:27	%AAA-I-CONNECT: New http connection for user admin, source 203.72.153.57 destination 10.227.29.102 ACCEPTED
4	10-May-2010 20:59:10	%LINK-W-Down: 2:1
5	10-May-2010 20:32:55	%STP-W-PORTSTATUS: 2:1: STP status Forwarding
6	10-May-2010 20:32:25	%LINK-I-Up: 2:1
7	10-May-2010 20:32:24	%LINK-W-Down: 2:1
8	10-May-2010 20:15:23	%STP-W-PORTSTATUS: 2:1: STP status Forwarding
9	10-May-2010 20:14:53	%LINK-I-Up: 2:1
10	10-May-2010 20:14:51	%LINK-W-Down: 2:1
11	10-May-2010 20:14:29	%LINK-I-Up: 2:1
12	10-May-2010 20:14:27	%LINK-W-Down: 2:1
13	10-May-2010 16:30:01	%LINK-W-Down: 1:16
14	10-May-2010 16:29:55	%LINK-I-Up: 1:16
15	10-May-2010 16:29:53	%LINK-W-Down: 1:16
16	10-May-2010 16:17:55	%STP-W-PORTSTATUS: 1:14: STP status Forwarding
17	10-May-2010 16:17:25	%LINK-I-Up: 1:14
18	10-May-2010 16:17:23	%LINK-W-Down: 1:14
19	10-May-2010 16:10:13	%LINK-W-Down: 1:22
20	10-May-2010 16:09:44	%STP-W-PORTSTATUS: 1:15: STP status Forwarding
21	10-May-2010 16:09:14	%LINK-I-Up: 1:15
22	10-May-2010 16:09:12	%LINK-W-Down: 1:15
23	10-May-2010 16:08:51	%STP-W-PORTSTATUS: 1:22: STP status Forwarding
24	10-May-2010 16:08:24	%LINK-I-Up: 1:22

# MAC Address Table

MAC Address Table						
Unit	<input type="text" value="01"/>	Port	<input type="text" value="01"/>	<input type="button" value="Find"/>		
VLAN Name	<input type="text"/>			<input type="button" value="Find"/>		
MAC Address	<input type="text"/>			<input type="button" value="Find"/>		
<input type="button" value="Clear Static Entries"/>		<input type="button" value="Clear Dynamic Entries"/>		<input type="button" value="View All Entries"/>		<input type="button" value="Clear All Entries"/>
<b>Total entries on this page: 90.</b>						
VID	VLAN Name	MAC Address	Unit	Port	Type	
1	Default	00-21-91-A3-6F-00	1	1:24	Dynamic	
1	Default	00-26-5A-C0-70-CF	1	1:24	Dynamic	
1	Default	00-26-5A-C0-72-14	1	1:24	Dynamic	
1	Default	00-26-5A-C0-72-5F	1	1:24	Dynamic	
1	Default	00-26-5A-C0-72-91	1	1:24	Dynamic	
1	Default	00-26-5A-C0-74-21	1	1:24	Dynamic	
1	Default	00-26-5A-E2-6C-00	1	1:24	Dynamic	
5	lan	00-00-48-0E-15-7E	1	1:24	Dynamic	
5	lan	00-00-48-0E-78-A3	1	1:24	Dynamic	
5	lan	00-00-48-0E-B0-5F	1	1:24	Dynamic	
5	lan	00-00-48-3F-68-1F	1	1:24	Dynamic	
5	lan	00-00-48-49-A8-66	1	1:24	Dynamic	
5	lan	00-00-48-49-A8-68	1	1:12	Dynamic	
5	lan	00-04-E2-9A-F9-D3	1	1:24	Dynamic	
5	lan	00-04-E2-B6-28-40	1	1:24	Dynamic	
5	lan	00-00-00-00-00-00	1	1:24	Dynamic	

# Thin AP Debug

- 確認校內路由正常
- 所有設定都在AC
- 確認AC與Winoc運作正常

# DWC-2000 quick user guide



# 大綱

1. 系統基本介紹
2. Interface介紹
3. 如何管理AP & 升級AP firmware
4. 如何修改AP profile
5. 如何設定 captive portal
6. 應用案例介紹

# 系統基本介紹

- 設備預設IP是 192.168.10.1
- 登入URL為 <http://192.168.10.1>
- 帳號/密碼: admin/admin
- 在沒有額外購買AP license情況下,可以管理64台AP
- 支援RADIUS和AD認證
- 可以針對不同VLAN派發IP, 但要在route mode架構下

Status » Dashboard

The Discovered APs, WLAN Statistics, Hardware Resources (CPU and Memory utilization) and Network Traffic through the Controller is displayed for each interface.

檢視系統資訊, AP數量, 連線人數

管理AP, 設定SSID, 設定RADIO

設定IP, VLAN, port, VLAN

設定RADIUS, LDAP,

PING, firmware upgrade, AP firmware upgrade & system time

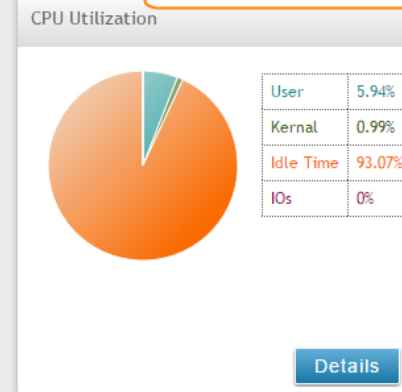
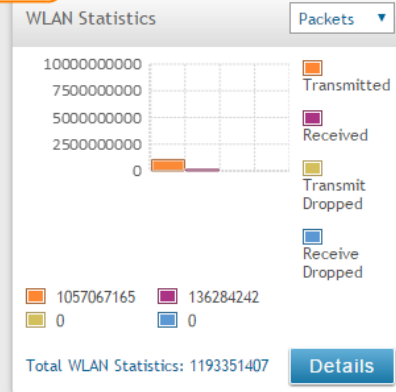
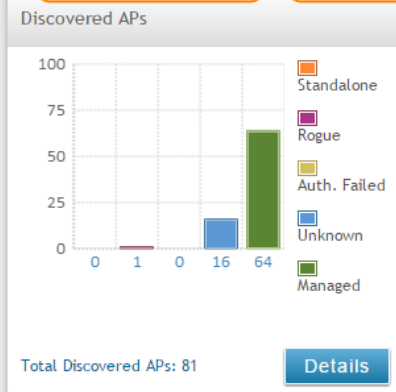

# Interface介紹

- 設備正面有四個RJ-45 interface 和 4個SFP介面,總共八個interface,但他們是combo port,意思是說當我如果接上RJ-45 port1的話,SFP的port1會無法使用.
- 在default configuration的情況下,四個interface都是同一個VLAN.
- 設備支援L3 VLAN 和 VLAN routing
- 設備支援route mode 和 NAT mode.

# 如何管理AP & 升級AP firmware

- DWL-8610AP & DWL-6610AP 一但被DWC-2000管理之後,便無法直接使用telnet & http 的方式去操作AP並且幫他做firmware upgrade, 要從DWC-2000的 Maintenance»Firmware»AP Firmware Download 去幫AP 做 firmware upgrade.
- 由於此操作只能用tftp的方式進行,請先在電腦上準備好 tftp server, 推薦使用 tftpd32 ([http://tftpd32.jounin.net/tftpd32\\_download.htm](http://tftpd32.jounin.net/tftpd32_download.htm)!)
- 整個AP升級過程大約要五分鐘

It may take about 12 minutes for the upgrade process to complete for an AP.

AP Firmware Download AP Firmware Status

The Unified Wireless Controller can upgrade software on the APs that it manages. The Cluster Controller can update code on APs managed by peer wireless controllers.

AP Firmware Download

Server Address	<input type="text"/>
Img_dwl8600	D-Link 8600 AP Radios
File Path	<input type="text"/>
File Name	<input type="text"/>
Img_dwl3600/6600	D-Link 3600/6600 AP Radios
File Path	<input type="text"/>
File Name	<input type="text"/>
Img_dwl2600	D-Link 2600 AP Radios
File Path	<input type="text"/>
File Name	<input type="text"/>
Img_dwl8610	D-Link 8610 AP Radios
File Path	<input type="text"/>
File Name	<input type="text"/>
Img_dwl6700	D-Link 6700 AP Radios
File Path	<input type="text"/>
File Name	<input type="text"/>
Img_dwl6610	D-Link 6610 AP Radios
File Path	<input type="text"/>
File Name	<input type="text"/>
Img_dwl8710	D-Link 8710 AP Radios
File Path	<input type="text"/>
File Name	<input type="text"/>
Group Size	<input type="text" value="6"/> [Default: 64, Range: 1 - 192]
Image Download Type	<input type="text" value="DWL-6610AP"/>
Managed AP	<input type="text" value="All"/> 3c:1e:04:f8:ed:c0-10.192.92.100 - 3c:1e:04:f8:f1:00-10.192.130.100 - 3c:1e:04:f8:f1:40-10.192.129.100 - 3c:1e:04:f8:f4:40-10.192.115.100 - 3c:1e:04:f8:f4:80-10.192.116.100 - 3c:1e:04:f8:f4:c0-10.192.123.100 - 3c:1e:04:f8:f5:00-10.192.122.100 -
<input type="button" value="Save"/> <input type="button" value="Start"/> <input type="button" value="Refresh"/>	

請輸入 TFTP server IP address

輸入firmware檔名,例如  
dwl-6610\_fw\_v\_4.3.0.4.tar

Group size建議用 6 ~ 8, 這是指一次幫幾台ap做升級動作。  
選擇哪一款ap要做升級,這邊我們選 6610AP

最後按下 save. 切記,要先save再start.

# 如何修改AP profile

- 最多可以建立64個 AP profile. Profile 裡面又包含了 radio & SSID.
- SSID 最多可以建立50個.

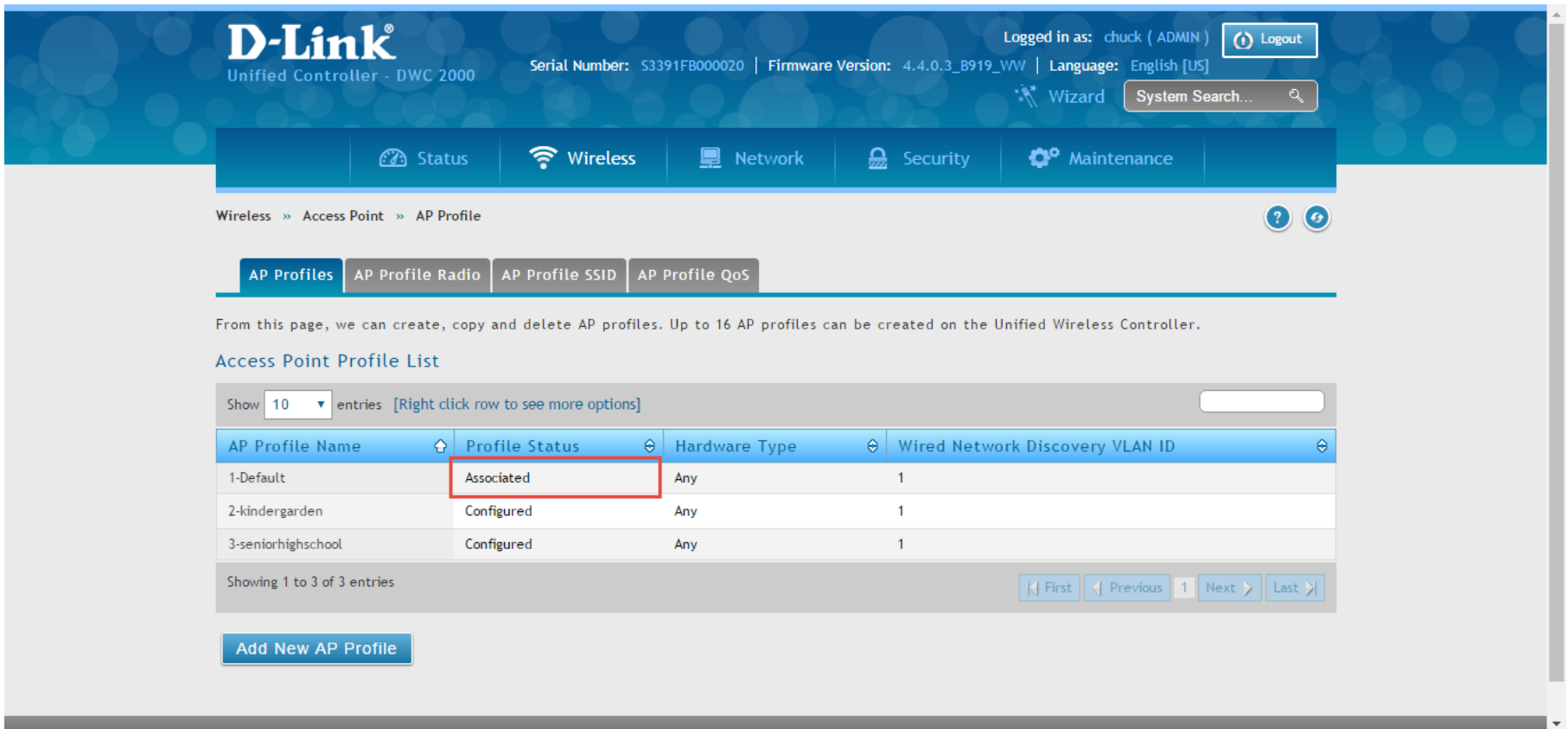

The screenshot displays the D-Link Unified Controller web interface. At the top, the D-Link logo and 'Unified Controller - DWC 2000' are visible. The user is logged in as 'chuck (ADMIN)' with a 'Logout' button. System information includes 'Serial Number: S3391FB000020', 'Firmware Version: 4.4.0.3\_B919\_VW', and 'Language: English [US]'. A 'Wizard' icon and a 'System Search...' input field are also present.

The main navigation bar includes 'Status', 'Wireless', 'Network', 'Security', and 'Maintenance'. The current page is 'Wireless >> Access Point >> AP Profile', with sub-tabs for 'AP Profiles', 'AP Profile Radio', 'AP Profile SSID', and 'AP Profile QoS'.

Below the tabs, a text block states: 'From this page, we can create, copy and delete AP profiles. Up to 16 AP profiles can be created on the Unified Wireless Controller.'

The 'Access Point Profile List' section features a table with the following data:

AP Profile Name	Profile Status	Hardware Type	Wired Network Discovery VLAN ID
1-Default	Associated	Any	1
2-kindergarden	Configured	Any	1
3-seniorhighschool	Configured	Any	1

The table shows 3 entries, with the first row highlighted. Below the table, there are navigation buttons: 'First', 'Previous', '1', 'Next', and 'Last'. A 'Show 10 entries [Right click row to see more options]' dropdown is located above the table. At the bottom, there is a blue button labeled 'Add New AP Profile'.

- 紅色框框是代表這個radio是開還是關,如果有某一個radio不想使用,就設定成off

The screenshot shows the D-Link Unified Controller interface. At the top, it displays the D-Link logo, 'Unified Controller - DWC 2000', and user information: 'Logged in as: chuck (ADMIN)' with a 'Logout' button. It also shows 'Serial Number: S3391FB000020', 'Firmware Version: 4.4.0.3\_B919\_VWV', and 'Language: English [US]'. There is a 'Wizard' icon and a 'System Search...' field.

The navigation menu includes 'Status', 'Wireless', 'Network', 'Security', and 'Maintenance'. The breadcrumb trail is 'Wireless » Access Point » AP Profile » AP Profile Radio'. Below this are tabs for 'AP Profiles', 'AP Profile Radio', 'AP Profile SSID', and 'AP Profile QoS'. The 'AP Profile Radio' tab is active.

A text block explains: 'This page contains several parameters that are not available for the default AP Profile. AP can support up to two radios. By default, Radio 1 operates in the IEEE 802.11a/n/ac mode and Radio 2 operates in the IEEE 802.11b/g/n mode. The difference between these modes is the frequency in which they operate. IEEE 802.11b/g/n operates in the 2.4 GHz frequency and IEEE 802.11a/n/ac operates in 5 GHz frequency.'

The 'Access Point Profiles Radio List' table is shown below. It has a 'Show 10 entries' dropdown and a search box. The table has 7 columns: 'AP Profile Name', 'Radio Mode', 'Status', 'Sentry Mode', 'Initial Power', 'Max. Clients', and 'Auto Eligible Channels'. The 'Status' column is highlighted with a red box. The table contains 6 rows of data.

AP Profile Name	Radio Mode	Status	Sentry Mode	Initial Power	Max. Clients	Auto Eligible Channels
1-Default	802.11a/n/ac	On	Disabled	100%	200	149
1-Default	802.11b/g/n	On	Disabled	100%	200	1,6,11
2-kindergarden	802.11a/n	On	Disabled	100%	30	60,149,157
2-kindergarden	802.11b/g/n	On	Disabled	100%	30	1,6,11
3-seniorhighschool	802.11a/n	On	Disabled	100%	30	60,149,157
3-seniorhighschool	802.11b/g/n	On	Disabled	100%	30	1,6,11

Showing 1 to 6 of 6 entries

Navigation buttons: First, Previous, 1, Next, Last



- 只有第一個SSID會預設就是enable, 如果有使用二個以上, 請記得要把他設定成enable, 2個radio都要設定

Wireless » Access Point » AP Profile » AP Profile SSID

AP Profiles | AP Profile Radio | **AP Profile SSID** | AP Profile QoS

This page displays the virtual access point(VAP) settings associated with the selected AP profile. Each VAP is identified by its network number and Service Set Identifier(SSID). We can configure and enable up to 16 VAPs per radio on each physical access point.

### Access Point Profiles SSID List

AP Profile: 1-Default

Radio Mode:  802.11a/n/ac  802.11b/g/n

Show 10 entries [Right click row to see more options]

SSID Name	SSID Status	VLAN	Hide SSID	Security	Redirect	L3 Tunnel	Captive Portal
18-NTPC-WPA2	Enabled	1-Default	Disabled	WPA Enterprise	None	Disabled	Free
21-Eduroam	Enabled	1-Default	Disabled	WPA Enterprise	None	Disabled	Free
22-NTPC-WPA-KEY	Enabled	1-Default	Disabled	WPA Personal	None	Disabled	Free
4-dlink4	Disabled	1-Default	Disabled	None	None	Disabled	Free
5-dlink5	Disabled	1-Default	Disabled	None	None	Disabled	Free
6-dlink6	Disabled	1-Default	Disabled	None	None	Disabled	Free
7-dlink7	Disabled	1-Default	Disabled	None	None	Disabled	Free
8-dlink8	Disabled	1-Default	Disabled	None	None	Disabled	Free

- 有更改radio or SSID設定的話,請記得要選 **apply** 去把設定推給AP.
- **Associated** 代表這個 AP profile有管理AP

The screenshot shows the D-Link Unified Controller web interface. The top navigation bar includes 'Status', 'Wireless', 'Network', 'Security', and 'Maintenance'. The 'Wireless' section is active, and the 'AP Profile' page is displayed. The 'AP Profiles' tab is selected, and the 'AP Profile List' is shown. The table lists three profiles: '1-Default' (Associated), '2-kindergarden' (Configured), and '3-seniorhighschool' (Configured). A context menu is open over the 'Associated' status of the '1-Default' profile, with the 'Apply' option highlighted. The 'Apply' option is marked with a green checkmark, indicating it is the selected action.

AP Profile Name	Profile Status	Hardware Type	Wired Network Discovery VLAN ID
1-Default	Associated	Anv	1
2-kindergarden	Configured		1
3-seniorhighschool	Configured		1

Showing 1 to 3 of 3 entries

Buttons: First, Previous, 1, Next, Last

Copyright © 2014 D-Link Corporation.

# 如何設定 captive portal

- 要在DWC-2000上面使用captive portal有二種方式, switch mode & route mode. 由於使用route mode的認證速度較快,在此我們只介紹這種架構.
  - 要使用route mode意味者dwc-2000要有二個網段,一個是uplink subnet, 另一個是 downlink subnet.
  - Route mode架構請使用 FW\_4.4.0.3\_B931 以上的版本.
  - Uplink一定要使用 VLAN1, downlink可以自行設定
  - 模擬架構圖如下:
- 
- 203.72.154.18(port 1 vlan1) DWC (port 2 vlan40) 192.168.100.254

**IPv4 LAN Settings**

## IPv6 LAN Settings

## IPv6 Address Pools

## IPv6 Prefix Length

## Router Advertisement

## Advertisement Prefixes

The LAN Configuration page allows you to configure the LAN interface of the controller including the DHCP Server which runs on it and Changes here affect all devices connected to the controller's LAN switch and also wireless LAN clients. Note that a change to the LAN IP address will require all LAN hosts to be in the same subnet and use the new address to access this GUI.

### LAN Settings

**IP Address Setup**IP Address Subnet Mask **DHCP Setup**DHCP Mode Domain Name **Default Route**Enable Default Route Gateway DNS Server SNAT  OFF**DNS Host Name Mapping**[\[Right click row to see more options\]](#)

- 從 VLAN list 可以新增修改 VLAN 設定

The screenshot displays the D-Link Unified Controller - DWC 2000 web interface. The top navigation bar includes the D-Link logo, system information (Serial Number: 53391FB000020, Firmware Version: 4.4.0.3\_B919\_WW, Language: English [US]), and a 'Logout' button. Below the navigation bar, there are tabs for Status, Wireless, Network, Security, and Maintenance. The 'Network' tab is selected, and the breadcrumb path is 'Network >> VLAN >> VLAN Settings'. A help icon and a refresh icon are visible in the top right corner of the content area.

The main content area contains a descriptive paragraph: "The controller supports virtual network isolation on the LAN with the use of VLANs. LAN devices can be configured to communicate in a subnetwork defined by VLAN identifiers."

Below the paragraph is the 'VLAN List' section. It features a 'Show 10 entries [Right click row to see more options]' control. The table below lists the configured VLANs:

Name	VLAN ID	VLAN Type	IP Address	Subnet Mask	Captive Portal	Authentication Server
Default	1	VLAN (L3)	203.72.154.18	255.255.255.0	Free	None
Mobile	36	VLAN (without IP interface)	NA	NA	NA	NA
NTPC	30	VLAN (without IP interface)	NA	NA	NA	NA
WPA2	35	VLAN (without IP interface)	NA	NA	NA	NA

Below the table, it indicates 'Showing 1 to 4 of 4 entries' and provides navigation buttons: First, Previous, 1, Next, Last.

At the bottom of the page, there is a blue button labeled 'Add New VLAN' and a section titled 'Available VLAN(s)'.

### VLAN Configuration

VLAN ID:  [Default: 1, Range: 2 - 4093]

Name:

VLAN Type:  VLAN (L3)  VLAN (without IP interface)

Activate InterVLAN Routing:  ON  OFF

Captive Portal Type:

Enable Redirect:  ON  OFF

Authentication Server:

Authentication Type:

**Captive Portal Profile**  
Choose Profile:  Login Profile  Custom Profile

Login Profile Name:  [Create a Profile](#)

Save

Add New VLAN

Available VLAN(s)

### VLAN Configuration

Authentication Server

Authentication Type

#### Captive Portal Profile

Choose Profile

Login Profile  Custom Profile

Login Profile Name

[Create a Profile](#)

#### Multi VLAN Subnet

IP Address

Subnet Mask

#### DHCP

DHCP Mode  None  DHCP Server  DHCP Relay

#### LAN Proxy

Enable DNS Proxy  OFF

Save

Add New VLAN

Available VLAN(s)

- Port VLAN 可以設定每個port使用哪個VLAN

**D-Link**  
Unified Controller - DWC 2000

Logged in as: chuck (ADMIN) [Logout](#)

Serial Number: S3391FB000020 | Firmware Version: 4.4.0.3\_B919\_VW | Language: English [US]

Wizard

Status Wireless Network Security Maintenance

Network >> VLAN >> Port VLAN

This page allows user to configure the port VLANs. A user can choose ports and can add them into a VLAN. In order to tag all traffic through a specific LAN port with a VLAN ID, you can associate a VLAN to a physical port. The VLAN Port table displays the port identifier, the mode setting for that port and VLAN membership information. Go to the Available VLAN page to configure a VLAN membership that can then be associated with a port

Port VLANs List

[Right click row to see more options]

Port Name	Mode	PVID	VLAN Membership
port1	Access	1	1
port2	Access	40	1
port3	Access	1	1
port4	Access	1	1

Showing 1 to 4 of 4 entries

Copyright © 2014 D-Link Corporation.



- 此處設定RADIUS server 參數

The screenshot displays the D-Link Unified Controller web interface. At the top, the D-Link logo and 'Unified Controller - DWC 2000' are visible on the left. On the right, it shows 'Logged in as: chuck ( ADMIN )' with a 'Logout' button. Below this, system information includes 'Serial Number: S3391FB000020', 'Firmware Version: 4.4.0.3\_B919\_WW', and 'Language: English [US]'. A 'Wizard' icon and a 'System Search...' input field are also present.

The main navigation bar contains icons for 'Status', 'Wireless', 'Network', 'Security', and 'Maintenance'. The current page path is 'Security » Authentication » External Auth Server » Radius Server'. Below this, there are tabs for 'Radius Server', 'Radius Accounting', 'POP3 Server', 'POP3 Trusted CA', and 'LDAP Server'. The 'Radius Server' tab is selected.

The page content includes a descriptive paragraph: 'This page configures the RADIUS servers to be used for authentication. A RADIUS server maintains a database of user accounts used in larger environments. If a RADIUS server is configured in the LAN, it can be used for authenticating users that want to connect to the wireless network provided by this device. If the first/primary RADIUS server is not accessible at any time, then the device will attempt to contact the secondary RADIUS server for user authentication.'

The 'Radius Server Configuration' section features a 'Server Check' area with a 'Server Checking' button. The configuration fields are as follows:

Field	Value	Range
Authentication Server 1 IP Address	203.72.153.61	
Authentication Port	1812	[Range: 0 - 65535]
Secret	.....	
Timeout	1	[Range: 1 - 999] Seconds
Retries	2	[Range: 1 - 9] Seconds

# 應用案例介紹三峽明德中學國中部教室無線網路架構

- 客人的需求是在每一間教室裝一間AP, 並且SSID名稱要跟教室名稱一樣, 代表了每間教室的SSID都是不同的並且每個AP要用不同的AP profile.
- 設定順序如下:
- 設定L2 VLAN ID
- 設定SSID
- 設定 AP profile
- 把SSID拉進去匹配的AP profile
- 納管AP, 每台AP用不同的AP profile.

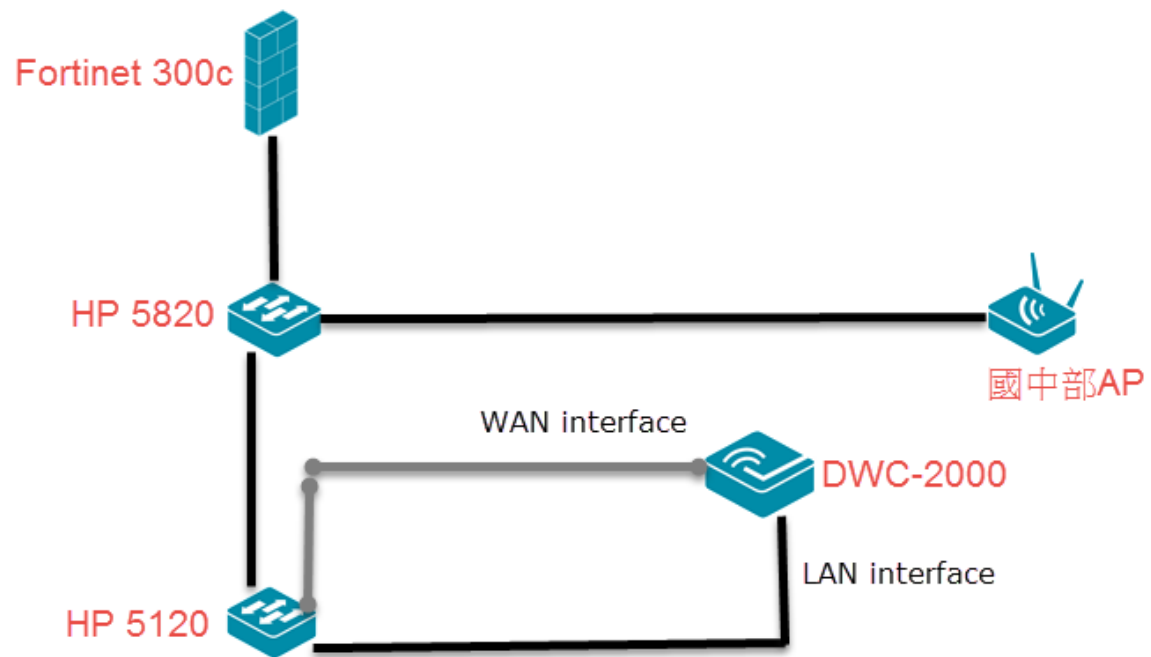

- 設定L2 VLAN ID

Network » VLAN » VLAN Settings

The controller supports virtual network isolation on the LAN with the use of VLANs. LAN devices can be configured to communicate in a subnetwork defined by VLAN identifiers.

VLAN List

Show 10 entries [Right click row to see more options]

Name	VLAN ID	VLAN Type	IP Address	Subnet Mask	Captive Portal	Authentication Server
Default	1	VLAN (L3)	10.253.33.1	255.255.255.0	Free	None
Mobile	36	VLAN (without IP interface)	NA	NA	NA	NA
vlan30	30	VLAN (L3)	10.251.33.254	255.255.255.0	External CP Web	radius
vlan35	35	VLAN (without IP interface)	NA	NA	NA	NA
vlan601	601	VLAN (without IP interface)	NA	NA	NA	NA
vlan602	602	VLAN (without IP interface)	NA	NA	NA	NA
vlan603	603	VLAN (without IP interface)	NA	NA	NA	NA
vlan604	604	VLAN (without IP interface)	NA	NA	NA	NA
vlan605	605	VLAN (without IP interface)	NA	NA	NA	NA
vlan606	606	VLAN (without IP interface)	NA	NA	NA	NA

Showing 1 to 10 of 24 entries

First Previous 1 2 3 Next Last

- 設定SSID

SSID Profile List

Show 25 entries [Right click row to see more options]

SSID Id	Name	VLAN	Hide SSID	Security	Redirect	L3 Tunnel	Captive Portal	Authentication Server
1	NTPC	30-vlan30	Disabled	None	None	Disabled	Free	None
2	NTPC-WPA2	35-vlan35	Disabled	WPA ENTERPRISE	None	Disabled	Free	None
3	NTPC-Mobil...	36-Mobile	Disabled	None	None	Disabled	Free	None
4	302-J302	622-vlan622	Disabled	WPA PERSONAL	None	Disabled	Free	None
5	304-J304	624-vlan624	Disabled	WPA PERSONAL	None	Disabled	Free	None
6	306-J306	626-vlan626	Disabled	WPA PERSONAL	None	Disabled	Free	None
7	308-J308	628-vlan628	Disabled	WPA PERSONAL	None	Disabled	Free	None
8	201-J315	611-vlan611	Disabled	WPA PERSONAL	None	Disabled	Free	None
9	203-J317	613-vlan613	Disabled	WPA PERSONAL	None	Disabled	Free	None
10	205-J319	615-vlan615	Disabled	WPA PERSONAL	None	Disabled	Free	None
11	207-J321	617-vlan617	Disabled	WPA PERSONAL	None	Disabled	Free	None
12	209-J323	619-vlan619	Disabled	WPA PERSONAL	None	Disabled	Free	None
13	dlink13	1-Default	Disabled	None	None	Disabled	Free	None
14	dlink14	1-Default	Disabled	None	None	Disabled	Free	None
15	dlink15	1-Default	Disabled	None	None	Disabled	Free	None
16	dlink16	1-Default	Disabled	None	None	Disabled	Free	None
17	101-J316	601-vlan601	Disabled	WPA PERSONAL	None	Disabled	Free	None

## SSID Profile Configuration



SSID

Captive Portal Type

Login Profile Name  [Create a Profile](#)

Hide SSID  OFF

Ignore Broadcast  OFF

VLAN  [Range: 1 - 4093]

L3 Tunnel  OFF

L3 Tunnel Status **Not Configured**

MAC Authentication  Local  Radius  Disable

Redirect  None  HTTP

Save

- 設定 AP profile.

Wireless > Access Point > AP Profile

AP Profiles | AP Profile Radio | AP Profile SSID | AP Profile QoS

From this page, we can create, copy and delete AP profiles. Up to 16 AP profiles can be created on the Unified Wireless Controller.

Access Point Profile List

Show 10 entries [Right click row to see more options]

AP Profile Name	Profile Status	Hardware Type	Wired Network Discovery VLAN ID
1-Default	Associated	Any	1
10-J318	Associated	Any	1
11-J320	Associated	Any	1
15-J302	Associated	Any	1
16-J304	Associated	Any	1
17-J306	Associated	Any	1
18-J308	Associated	Any	1
19-J315	Associated	Any	1
2-J216	Associated	Any	1
21-J319	Configured	Any	1

- 把SSID拉進去匹配的AP profile

Wireless » Access Point » AP Profile » AP Profile SSID

AP Profiles | AP Profile Radio | **AP Profile SSID** | AP Profile QoS

This page displays the virtual access point(VAP) settings associated with the selected AP profile. Each VAP is identified by its network number and Service Set Identifier(SSID). We can configure and enable up to 16 VAPs per radio on each physical access point.

Access Point Profiles SSID List

AP Profile: **2-J216**

Radio Mode:  802.11a/n  802.11b/g/n

Show 10 entries [Right click row to see more options]

SSID Name	SSID Status	VLAN	Hide SSID	Security	Redirect	L3 Tunnel	Captive Portal
1-NTPC	Enabled	30-vlan30	Disabled	None	None	Disabled	Free
2-NTPC-WPA2	Enabled	35-vlan35	Disabled	WPA Enterprise	None	Disabled	Free
3-NTPC-Mobile	Disabled	36-Mobile	Disabled	None	None	Disabled	Free
17-101-J216	Enabled	601-vlan601	Disabled	WPA Personal	None	Disabled	Free
5-304-J304	Disabled	624-vlan624	Disabled	WPA Personal	None	Disabled	Free
6-306-J306	Disabled	626-vlan626	Disabled	WPA Personal	None	Disabled	Free
7-308-J308	Disabled	628-vlan628	Disabled	WPA Personal	None	Disabled	Free
8-201-J315	Disabled	611-vlan611	Disabled	WPA Personal	None	Disabled	Free



- 納管AP, 每台AP用不同的AP profile.

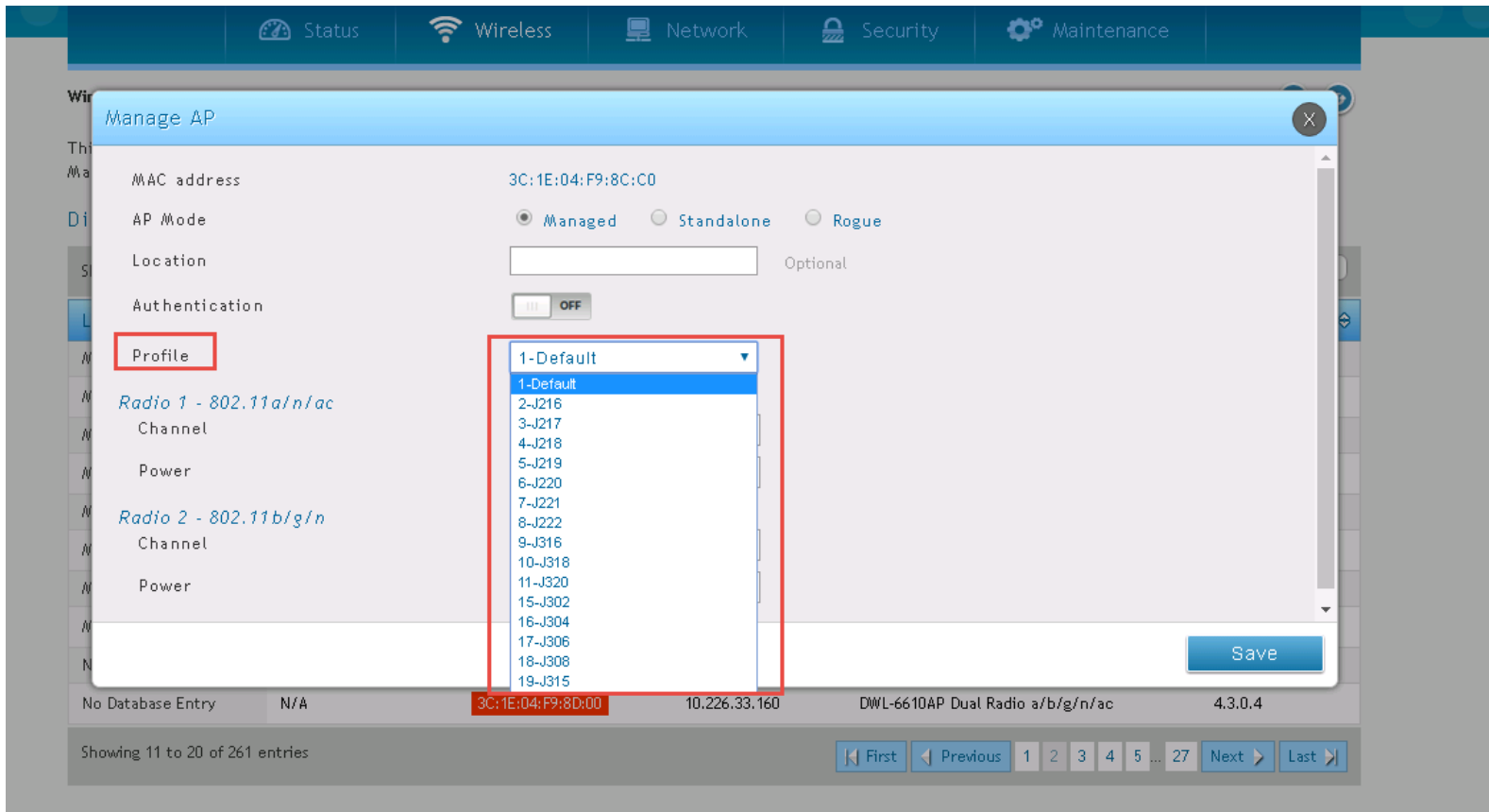

# 附錄

- DWC-2000 firmware 4.4.0.3\_B931\_WW\_Q
- <https://drive.google.com/file/d/0B1qEQfkSaQCrZXA0cTBjRTZoN0E/view?usp=sharing>
  
- DWL-6610AP firmware 4.3.0.4
- <https://drive.google.com/file/d/0B1qEQfkSaQCrZ0p5YWxpeExVY2s/view?usp=sharing>

# NTPC除錯

- 1.Vlan 30 Trunk Port 對嗎?
- 2.Vlan 30 GW是否到的了
- 3. DWC-2000是否掛點?
- 4. DWC-2000是否認證成功?
- 5.Vlan 8路由正常否?
- 6. DWC-2000看user log
- 7.Firewall上查Policy ◦
- 8.Core Routing

# NTPC-Mobile除錯

- 1.Vlan 36 Trunk port
- 2.AP MAC
- 3.L2 MAC
- 4.L3 MAC
- 5.L3 unblock
- 6.Wan ip 是否有發radius服務
- 7.firewall Policy
- 8.vlan interface and routing

# WPA2-除錯

- Vlan 35 trunk port
- Vlan 1 or Vlan35 AP ip to Radius
- AP MAC
- Check Policy
- Vlan interface and Routing

# Thin AP除錯

- 1.AC Discovery
- 2.Tunnel Mode or Bridge Mode
- 3.Radius Server
- 4.DHCP
- 5.IP Pool setup
- 6.Firewall Routing
- 7.Bridge switch setup(Check MAC)
- 8.Policy

# Firewall Sniffer

- Config vdom
- Edit v256-vd
- Diagnose sniffer packet any “host X.X.X.X” 4

# Sflow Local Traffic 監控

- 校園設定一台PC，安裝sFlowTrend.jnlp and java
- 請中心工程師在3620下達指令
  1. enable sflow
  2. create sflow analyzer\_server 1 owner NTPC  
timeout infinite collectoraddress 163.20.66.190  
collectorport 6343 maxdatagramsize 1400
  3. create sflow flow\_sampler ports 1:1-24  
analyzer\_server\_id 1 rate 1 tx\_rate 1  
maxheadersize 256
  4. delete sflow flow\_sampler ports 1:1-24



# Sflow與中心端Siraya之差異

- Local traffic 監控
- 骨幹出問題時可以知道校內流量及原因。
- 詳細的Local Traffic

# 舊有FAT AP納管

- 學校內的舊FAT AP可完全支援所有認證方式
  - 舊有AP功能可支援NTPC-WPA2及NTPC-Mobile設定部份可參考以下兩者進行調整
  - NTPC規劃設定Vlan8 10.253.XX.254 and Vlan 30傳送Data traffic。
  - NTPC-WPA2認證部分，
    - FAT AP認證系統需要加入此AP ip (Vlan1)，並帶(Vlan35)傳送Data traffic。
  - NTPC-Mobile 認證依舊由L3 Switch進行認證。
    - 認證系統需要加入L3 switch ip (Vlan1)，並帶(Vlan36)傳送Data traffic。

# 問題討論

- 訊號不佳
  - Wifi analyzer
- 無法進入認證可能問題
  - 測Radius
- 特定網路位址不通，服務不通？
  - Firewall policy
- 無法辦公文？
  - DNS

# 總 結

- Wifi analyzer頻譜，分析訊號強弱。
- Wireless :
  - NTPC Web portal、NTPC- WPA2、NTPC- Mobile、EduRoaming、TanetRoam
- Radius認證(Winoc)
  - 納管FAT AP Radius 認證及MAC Auth帳號。
  - 處理AC Radius認證
- FireWall Policy
  - 處理10.128/9 做NAT(163.20.242~243/23)
  - 引導網段至Winoc做Radius認證
- Thin AP 架構及啟動行為設計
- IP不夠用問題：
  - 舊架構擴充發四個C
  - 新架構一個B，原來的C當ip pool

# 附錄

## windows 7 開啟telnet 功能

The screenshot shows the Windows 7 'Windows 功能' (Windows Features) control panel window. The 'Telnet 用戶端' (Telnet Client) feature is checked. The background shows a list of installed software with columns for name, size, and version.

名稱	大小	版本
Transcend SSD Scope version 2.7.0	8.40 MB	2.7.0.0
VAIO Control Center	800 KB	7.4.9.44981
Juniper Networks, Inc. Setup Client	101 MB	11.0.4665
趨勢科技 OfficeScan 代理程式		
HDAUDIO SoftV92 Data Fax Moder		
EasyATM Smart Wizard	2.02 MB	1.00.0000
Smart Card Reader Installer	2.14 MB	1.1.9.0923
Microsoft Visual Studio 2010 Tools		10.0.50903
Microsoft Visual Studio 2010 Tools		10.0.50903
綜合所得稅電子結算申報繳稅系統	24.4 MB	16.22.104.0511
Microsoft Visual C++ 2010 x86 Rec	11.1 MB	10.0.40219
iTools 3		
Apple Mobile Device Support	22.5 MB	8.1.0.18
Apple 應用程式支援 (32 位元)	94.3 MB	3.1.1
ISO to USB	5.26 MB	
Mobile Partner		23.003.07.04.68
WinMerge 2.14.0	5.73 MB	2.14.0
Microsoft Visual C++ 2008 Redistributable	2.06 MB	9.0.21022
Microsoft Visual C++ 2008 Redistributable	600 KB	9.0.30729.6161
Win32DiskImager version 0.9.5		
LINE	44.8 MB	0.9.5
Oracle VM VirtualBox 5.0.2		
ImageWriter Developers		2015/7/13
LINE Corporation		2015/8/17
Oracle Corporation		2015/8/20

**Windows 功能**

開啟或關閉 Windows 功能

若要開啟功能，請選取該功能的核取方塊。若要關閉功能，請清除該功能的核取方塊。填滿的方塊表示只開啟部分功能。

- Internet Information Services 可裝載的 Web 核心
- Microsoft .NET Framework 3.5.1
- Microsoft Message Queue (MSMQ) 伺服器
- RAS 連線管理員系統管理組件 (CMAK)
- RIP Listener
- Tablet PC 元件
- Telnet 用戶端
- Telnet 伺服器
- TFTP 用戶端
- Windows Search
- Windows TIFF IFilter
- Windows 小工具平台
- Windows 處理序啟用服務

確定 取消

# Win7 firewall



## 允許程式通過 Windows 防火牆通訊

若要新增、變更或移除允許的程式與連接埠，請按一下 [變更設定]。

[允許程式通訊的風險為何?](#)

變更設定(N)

允許的程式與功能(A):

名稱	家用/工作場所 (私人)	公用
<input type="checkbox"/> BranchCache - 內容抓取 (使用 HTTP)	<input type="checkbox"/>	<input type="checkbox"/>
<input type="checkbox"/> BranchCache - 同儕節點探索 (使用 WSD)	<input type="checkbox"/>	<input type="checkbox"/>
<input type="checkbox"/> BranchCache - 託管快取用戶端 (使用 HTTPS)	<input type="checkbox"/>	<input type="checkbox"/>
<input type="checkbox"/> BranchCache - 託管快取伺服器 (使用 HTTPS)	<input type="checkbox"/>	<input type="checkbox"/>
<input checked="" type="checkbox"/> C:\Program Files\DTLSoft\DriveTheLife\download\MiniThun...	<input checked="" type="checkbox"/>	<input checked="" type="checkbox"/>
<input checked="" type="checkbox"/> C:\Program Files\DTLSoft\DriveTheLife\DriveTheLife.exe	<input checked="" type="checkbox"/>	<input checked="" type="checkbox"/>
<input checked="" type="checkbox"/> C:\Program Files\DTLSoft\DriveTheLife\DTLService.exe	<input checked="" type="checkbox"/>	<input checked="" type="checkbox"/>
<input checked="" type="checkbox"/> Firefox (C:\Program Files\Mozilla Firefox)	<input checked="" type="checkbox"/>	<input type="checkbox"/>
<input checked="" type="checkbox"/> Firefox (C:\Program Files\Mozilla Firefox)	<input checked="" type="checkbox"/>	<input type="checkbox"/>
<input checked="" type="checkbox"/> Google Chrome	<input checked="" type="checkbox"/>	<input checked="" type="checkbox"/>
<input checked="" type="checkbox"/> HomeGroup	<input checked="" type="checkbox"/>	<input type="checkbox"/>

詳細資料(L)...    移除(M)

允許其他程式(R)...

確定

取消

# 中心firewall功能

- 做10網段NAT
- 對單一ip做session limit
- 阻擋P2P
- 做動態路由交換ospf
- 各校邏輯上的firewall分割Vdom
- IPS功能
- 監控封包除錯功能

# Dlink DWL 6610AP設定

- 先至AC開啟AP debug,設定admin password
- telnet 連上
- 設定AP ip
- 設定AC ip



# Dlink DWL 6610AP

- set management dhcp-status down  
set management static-ip 10.226.161.117  
set management static-mask 255.255.255.0  
set static-ip-route gateway 10.226.161.254  
set host id AP117  
set managed-ap switch-address-1 10.253.161.1  
set telnet status up  
set web-server http-status up  
save-running